

# Color Control GX Manual

# Table of Contents

<b>1. Safety instructions</b> .....	<b>1</b>
<b>2. Introduction</b> .....	<b>2</b>
2.1. What is the Color Control GX? .....	2
2.2. What's in the box? .....	2
<b>3. Installation</b> .....	<b>3</b>
3.1. Color Control GX Overview of connections .....	3
3.2. Mounting options and accessories .....	4
3.3. Powering the Color Control GX .....	5
3.3.1. Snap-on ferrite beads for class B EMI compliance .....	5
3.4. Relay connections .....	7
<b>4. Connecting Victron products</b> .....	<b>8</b>
4.1. VE.Bus Multis/Quattros/Inverters .....	8
4.2. AC load monitoring .....	9
4.3. Battery monitors, MPPTs and Smart IP43 Chargers with a VE.Direct port .....	9
4.3.1. DC load monitor mode .....	10
4.4. VE.Can Devices .....	11
4.5. VE.Can Interfaces .....	11
4.6. Inverter RS, Multi RS and MPPT RS .....	11
4.7. BMV-600 series .....	11
4.8. DC Link Box .....	12
4.9. VE.Can Resistive Tank Sender Adapter .....	12
4.10. Connecting a GX Tank 140 .....	12
4.11. Victron Energy Meter VM-3P75CT .....	12
4.12. EV Charging Station .....	13
<b>5. Connecting supported non-Victron products</b> .....	<b>15</b>
5.1. Connecting a PV Inverter .....	15
5.2. Connecting a USB GPS .....	15
5.3. Connecting a NMEA 2000 GPS .....	16
5.4. Connecting a Fischer Panda Generator .....	16
5.5. Connecting third-party NMEA 2000 tank senders .....	16
5.6. Mopeka Ultrasonic Bluetooth Sensors .....	18
5.6.1. Installation .....	18
5.6.2. Configuration .....	20
5.6.3. Tank level monitoring .....	21
5.7. Wakespeed WS500 alternator regulator support .....	22
5.7.1. Introduction .....	22
5.7.2. Requirements .....	22
5.7.3. Wiring the WS500 to VE.Can .....	22
5.7.4. Wiring Example .....	23
5.7.5. GX device user interface for WS500 .....	24
5.7.6. WS500 data on the VRM Portal .....	24
5.7.7. Troubleshooting & FAQ .....	25
5.8. Wireless Bluetooth Ruuvi temperature sensors .....	26
5.9. Connecting IMT Solar Irradiance, Temperature and Wind Speed Sensors .....	28
5.9.1. Data Visualisation - VRM .....	31
5.10. ComAp InteliLite 4 series genset controller support .....	31
5.10.1. Introduction .....	31
5.10.2. Installation & Configuration .....	32
5.11. DSE- Deep Sea generator controller support .....	34
5.11.1. Introduction .....	34
5.11.2. Installation & Configuration .....	35
5.12. Reading generic alternator data from compatible NMEA 2000 DC sensors .....	36
<b>6. Internet connectivity</b> .....	<b>37</b>
6.1. Ethernet LAN port .....	37
6.2. WiFi .....	38
6.3. GX LTE 4G .....	38
6.4. Mobile (cellular) network using a 3G or 4G router .....	38

6.5. USB tethering using a mobile phone .....	39
6.6. Manual IP configuration .....	39
6.7. Multiple connections (failover) .....	39
6.8. Minimise internet traffic .....	40
6.9. More information about setting up an internet connection and VRM .....	40
<b>7. Accessing the GX device .....</b>	<b>41</b>
7.1. Accessing the Remote Console via local LAN/WiFi Network .....	42
7.1.1. Alternative methods to find the IP address for Remote Console .....	42
7.2. Accessing via VRM .....	43
7.3. The Remote Console menu .....	44
<b>8. Configuration .....</b>	<b>45</b>
8.1. Menu structure and configurable parameters .....	45
8.2. Battery state of charge (SoC) .....	52
8.2.1. Which device should I use for SoC calculation? .....	52
8.2.2. The different solutions explained in detail .....	52
8.2.3. Notes on SoC .....	53
8.2.4. Selecting SoC source .....	53
8.2.5. Details on VE.Bus SOC .....	54
8.2.6. The System Status menu .....	54
8.3. Customise the logo on the Boat & Motorhome page .....	55
8.4. Temperature relay configuration .....	56
<b>9. Firmware updates .....</b>	<b>58</b>
9.1. Changelog .....	58
9.2. Updating from version 1.x to 2 .....	58
9.3. Via internet or with microSD-card/USB-stick .....	58
9.3.1. Direct download from the internet .....	58
9.3.2. microSD-card or USB-stick .....	59
9.4. Revert to a previous firmware version .....	59
9.4.1. Stored firmware backup feature .....	60
9.4.2. Install a specific firmware version from SD/USB .....	61
<b>10. VE.Bus Inverter/charger monitoring .....</b>	<b>62</b>
10.1. Input current-limiter setting .....	62
10.2. Phase rotation warning .....	63
10.3. BMS connection lost alarm .....	63
10.4. Grid failure monitoring .....	64
10.5. Advanced menu .....	64
10.6. Alarm status monitoring .....	65
10.7. VE.Bus alarm setup menu .....	65
10.8. Device menu .....	65
10.9. Solar & Wind Priority .....	66
<b>11. DVCC - Distributed Voltage and Current Control .....</b>	<b>67</b>
11.1. Introduction and features .....	67
11.2. DVCC Requirements .....	68
11.3. DVCC effects on the charge algorithm .....	69
11.3.1. DVCC effects when there is more than one Multi/Quattro connected .....	69
11.4. DVCC features for all systems .....	70
11.4.1. Limit charge current .....	70
11.4.2. Limit managed battery charge voltage .....	70
11.4.3. Shared Voltage Sense (SVS) .....	71
11.4.4. Shared Temperature Sense (STS) .....	71
11.4.5. Shared Current Sense (SCS) .....	72
11.4.6. Controlling BMS .....	72
11.5. DVCC features when using CAN-bus BMS battery .....	73
11.6. DVCC for systems with the ESS Assistant .....	74
<b>12. VRM Portal .....</b>	<b>75</b>
12.1. VRM Portal introduction .....	75
12.2. Registering on VRM .....	75
12.3. Datalogging to VRM .....	75

12.4. Troubleshooting data logging .....	77
12.5. Analysing data offline, without VRM .....	80
12.6. Remote Console on VRM - Setup .....	80
12.7. Remote Console on VRM - Troubleshooting .....	81
<b>13. Marine MFD integration by App .....</b>	<b>83</b>
13.1. Introduction & requirements .....	83
13.2. Raymarine MFD Integration .....	84
13.2.1. Introduction .....	84
13.2.2. Compatibility .....	84
13.2.3. Wiring .....	84
13.2.4. GX device configuration .....	85
13.2.5. Configuring multiple battery measurements .....	85
13.2.6. Installation step-by-step .....	85
13.2.7. NMEA 2000 .....	86
13.2.8. Generic and supported PGNs .....	86
13.2.9. Instancing requirements when using Raymarine .....	86
13.2.10. Before LightHouse 4.1.75 .....	86
13.2.11. LightHouse 4.1.75 and newer .....	87
13.3. Navico MFD Integration .....	87
13.3.1. Introduction .....	87
13.3.2. Compatibility .....	87
13.3.3. Wiring .....	88
13.3.4. GX device configuration .....	88
13.3.5. Configuring multiple battery measurements .....	88
13.3.6. Installation step-by-step .....	89
13.3.7. NMEA 2000 .....	89
13.3.8. Generic and supported PGNs .....	89
13.3.9. Troubleshooting .....	90
13.4. Garmin MFD Integration .....	90
13.4.1. Introduction .....	90
13.4.2. Compatibility .....	90
13.4.3. Wiring .....	90
13.4.4. GX device configuration .....	91
13.4.5. Configuring multiple battery measurements .....	91
13.4.6. Installation step-by-step .....	92
13.4.7. NMEA 2000 .....	92
13.4.8. Generic and supported PGNs .....	92
13.5. Furuno MFD Integration .....	93
13.5.1. Introduction .....	93
13.5.2. Compatibility .....	93
13.5.3. Wiring .....	93
13.5.4. Configuration .....	93
13.5.5. Configuring multiple battery measurements .....	94
13.5.6. NMEA 2000 .....	94
13.5.7. Generic and supported PGNs .....	95
<b>14. Marine MFD integration by NMEA 2000 .....</b>	<b>96</b>
14.1. NMEA 2000 Introduction .....	96
14.2. Supported Devices / PGNs .....	96
14.3. NMEA 2000 Configuration .....	98
14.4. Configuring Multiple Tank Level Measurements (Raymarine) .....	98
14.5. Configuring Multiple Tank Level Measurements (Garmin) .....	99
14.6. Configuring Multiple Tank Level Measurements (Navico) .....	100
14.7. Configuring Multiple Tank Level Measurements (Furuno) .....	102
14.8. NMEA2000-out technical details .....	102
14.8.1. NMEA 2000 Glossary .....	102
14.8.2. NMEA 2000 Virtual-devices .....	103
14.8.3. NMEA 2000 Classes and Functions .....	103
14.8.4. NMEA 2000 Instances .....	103
14.8.5. NMEA 2000 Changing Instances .....	104
14.8.6. PGN 60928 NAME Unique Identity Numbers .....	108
<b>15. RV-C Support .....</b>	<b>109</b>
15.1. RV-C Introduction .....	109
15.2. Limitations .....	109
15.3. Supported Devices .....	109



15.4. RV-C Configuration .....	110
15.4.1. Configuration of RV-C out devices .....	111
15.5. Garnet SeeLevel II 709-RVC & Victron GX device support .....	112
15.5.1. Wiring the Garnet SeeLevel II 709-RVC tank level sensor to a GX device .....	112
15.5.2. Installation and configuration .....	112
<b>16. GX - Generator auto start/stop .....</b>	<b>113</b>
16.1. Generator auto start/stop introduction .....	113
16.2. Wiring .....	113
16.3. Enabling the start/stop function .....	113
16.4. Generator start/stop menu .....	114
16.5. Settings menu .....	114
16.5.1. Alarm when autostart function is disabled .....	115
16.5.2. Run time and service interval menu .....	115
16.6. Conditions: User definable parameters that trigger an automatic generator start/stop .....	116
16.6.1. Stop generator when AC-input is available .....	116
16.6.2. Relays triggered by Battery SoC .....	117
16.6.3. Relays triggered by Battery Current .....	117
16.6.4. Relays triggered by Battery Voltage .....	117
16.6.5. Relays triggered by AC load .....	117
16.6.6. Relays triggered by Inverter High temperature .....	118
16.6.7. Relays triggered by Inverter overload .....	118
16.6.8. Automatic periodic 'Test run' .....	118
16.6.9. Manual Start Feature .....	118
16.6.10. Quiet hours .....	119
16.7. Troubleshooting .....	120
<b>17. Reset to factory defaults and Venus OS reinstall .....</b>	<b>121</b>
17.1. Reset to factory defaults procedure .....	121
17.2. Venus OS reinstall .....	121
<b>18. Troubleshooting .....</b>	<b>123</b>
18.1. Error Codes .....	123
18.2. FAQ .....	124
18.2.1. Q1: I cannot switch my Multi/Quattro system on or off .....	124
18.2.2. Q2: Do I need a BMV to see proper battery state of charge? .....	125
18.2.3. Q3: I have no internet, where can I insert a SIM card? .....	125
18.2.4. Q4: Can I connect both a GX Device and a VGR2/VER to a Multi/Inverter/Quattro? .....	125
18.2.5. Q5: Can I connect multiple Color Control GX to a Multi/Inverter/Quattro? .....	125
18.2.6. Q6: I see incorrect current (amps) or power readings on my CCGX .....	126
18.2.7. Q7: There is a menu entry named "Multi" instead of the VE.Bus product name .....	126
18.2.8. Q8: There is a menu entry named "Multi", while there is no Inverter, Multi or Quattro connected ..	126
18.2.9. Q9: When I type the IP address of the Color Control GX into my browser, I see a web page mentioning Hiawatha? .....	127
18.2.10. Q10: I have multiple Solar chargers MPPT 150/70 running in parallel. From which one will I see the relay status in the CCGX menu? .....	127
18.2.11. Q11: How long should an automatic update take? .....	127
18.2.12. Q12: I have a VGR with IO Extender, how can I replace this with a Color Control GX? .....	127
18.2.13. Q13: Can I use Remote VEConfigure, as I was doing with the VGR2? .....	127
18.2.14. Q14: The Blue Power Panel could be powered through the VE.Net network, can I also do that with a Color Control GX? .....	127
18.2.15. Q15: What type of networking is used by the Color Control GX (TCP and UDP ports)? .....	127
18.2.16. Q16: What is the functionality behind the menu item Remote support (SSH) in the Ethernet menu? .....	128
18.2.17. Q17: I don't see support for VE.Net products in the list, is that still coming? .....	128
18.2.18. Q18: What is the data usage of the Color Control GX? .....	128
18.2.19. Q19: How many AC Current Sensors can I connect in one VE.Bus system? .....	128
18.2.20. Q20: Issues with Multi not starting when CCGX is connected / Caution when powering the CCGX from the AC-out terminal of a VE.Bus Inverter, Multi or Quattro .....	128
18.2.21. Q21: I love Linux, programming, Victron and the CCGX. Can I do more? .....	129
18.2.22. Q22: How do I change the logo .....	129
18.2.23. Q23: Multi restarts all the time (after every 10sec) .....	129
18.2.24. Q24: What is Error #42? .....	129
18.2.25. Q25: My GX device reboots itself. What is causing this behavior? .....	129
18.2.26. <b>GPL Note</b> .....	130

<b>19. Technical specifications</b> .....	<b>131</b>
19.1. Technical specifications .....	131
<b>20. Appendix</b> .....	<b>132</b>
20.1. RV-C .....	132
20.1.1. Supported DGNs .....	132
20.1.2. RV-C out .....	132
20.1.3. DGN 60928 Unique Identity Numbers .....	138
20.1.4. RV-C in .....	138
20.1.5. Device Classes .....	138
20.1.6. Instance Translation .....	139
20.1.7. RV-C Fault and Error Handling .....	139
20.1.8. RV-C Device Priority .....	140
20.2. Color Control GX Dimensions .....	141
20.3. Modbus holding registers for the ComAp IntelliLite 4 controller .....	142
20.4. Modbus holding registers for supported DSE genset controllers .....	143

# 1. Safety instructions



**SAVE THESE INSTRUCTIONS – This manual contains important instructions that shall be followed during installation, setup, operation and maintenance.**

- Please read this manual carefully before the product is installed and put into use
- Make sure you have the latest version of the manual. The most recent version can be downloaded from the [product page](#).
- Install the product in a heatproof environment. Ensure therefore that there are no chemicals, plastic parts, curtains or other textiles, etc. in the immediate vicinity of the equipment.
- Ensure that the equipment is used under the correct operating conditions. Never operate it in a wet environment.
- Never use the product at sites where gas or dust explosions could occur
- This device is not to be used by persons (including children) with reduced physical, sensory or mental capabilities, or lack of experience and knowledge, unless they have been given supervision or instruction.

## 2. Introduction

### 2.1. What is the Color Control GX?

The Color Control GX is a member of the [GX product family](#) and is operated using control buttons directly on the built-in LCD display.

GX products are Victron's state-of-the-art monitoring and control solution that run our Venus OS operating system. It sits at the heart of your energy installation. All the other system-components such as inverter/chargers, solar chargers, and batteries are connected to it. The CCGX ensures that they all work in harmony.

To monitor and control your system, you can simply access it remotely via our [Victron Remote Management \(VRM\) portal](#) from anywhere in the world using an internet connection. Or access it directly, using the control buttons at the integrated LCD display, a web browser, a [Multi-Functional Display \(MFD\) \[83\]](#) or our [VictronConnect app](#)

The [Remote Console \[41\]](#) serves as the primary control center for monitoring, controlling and managing your system.

The CCGX also provides [VRM: Remote firmware updates](#) and allows settings to be changed remotely.

Note that all the information in this manual refers to the latest software. You can check your device has the latest version in the firmware menu (see the [Firmware updates \[58\]](#) chapter) when the GX device is connected to the internet. For installations without internet, you can find the latest version in [Victron Professional](#).

### 2.2. What's in the box?

- Color Control GX
- Power cable with inline fuse and M8 terminal eyes for battery or DC busbar-attachment
- Product Specification Datasheet and overview of connections
- Mounting bracket and screws
- Snap on ferrite beads
- VE.Can terminators (2 pcs)



## 3. Installation

### 3.1. Color Control GX Overview of connections

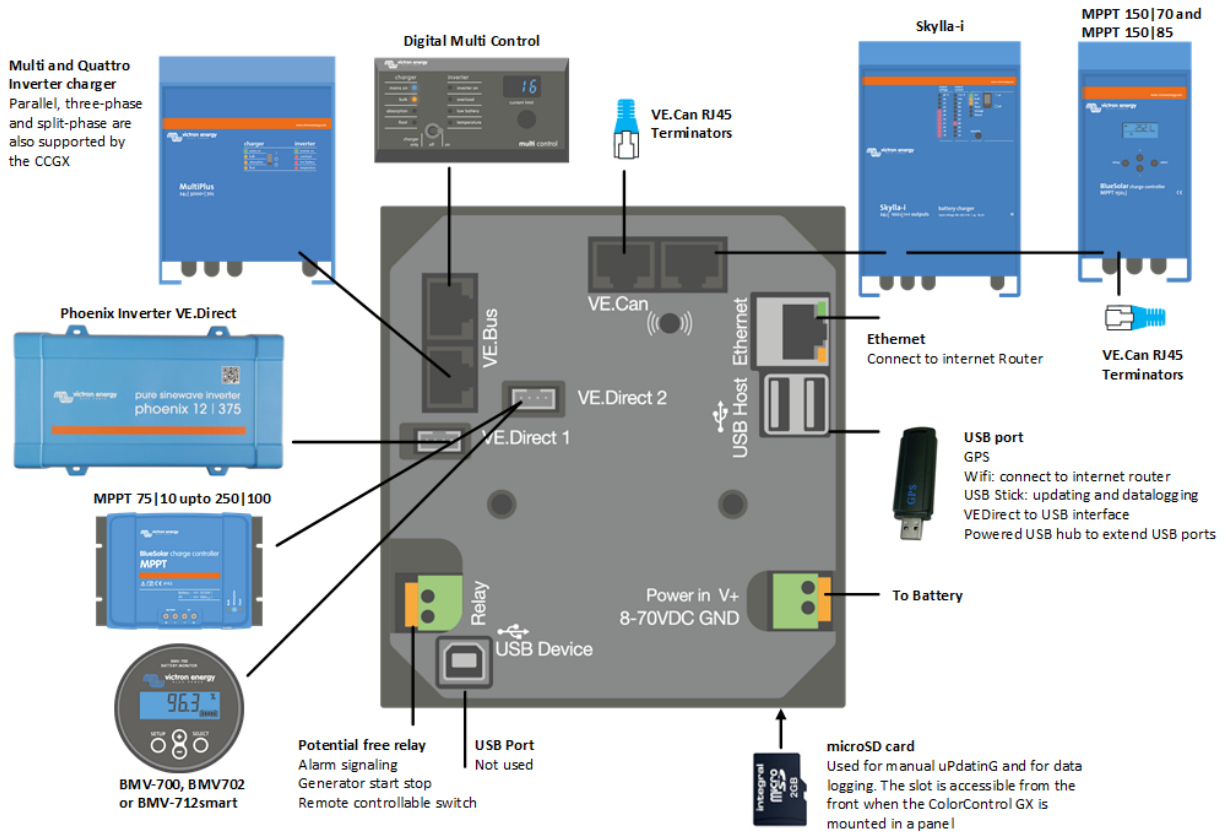

## 3.2. Mounting options and accessories

The following mounting options and accessories are available for purchase:

- [Combined wall mount enclosure for a BMV and Color Control GX](#)
- [Wall mount enclosure for Color Control GX](#)

### 3.3. Powering the Color Control GX

The device is powered by using the *Power in V+* connector. It accepts 8 to 70V DC. The device will not power itself from any of the other connections (eg network). The supplied DC power cable includes an inline 3.15A slow blow fuse.

When the CCGX is used in an installation with a VE.Bus BMS, connect the *Power in V+* on the CCGX to the terminal labelled '*Load disconnect*' on the VE.Bus BMS. Connect both negative leads to the negative stub of a common battery.

#### A cautionary word about powering from the AC-out terminal of a VE.Bus Inverter, Multi or Quattro:

If you power the CCGX from an AC adaptor connected to the AC-out port of any VE.Bus product (Inverter, Multi or Quattro), then a deadlock will occur after the VE.Bus products are powered-down for any reason (after any operational fault or during a black start). The VE.Bus devices will not boot-up until the CCGX has power ...but the CCGX will not boot-up until *it* has power. This deadlock can be rectified by briefly unplugging the CCGX VE.Bus cable at which point you will observe the VE.Bus products will immediately begin to boot-up.

Or a modification can be done to the RJ45 cabling. See [FAQ Q20 \[128\]](#) for more information about this.

Note that both with or without above modification, powering the monitoring equipment with the AC-out of an inverter/charger (of course) has the disadvantage that all monitoring is shut down when there is a problem that causes the inverter/charger to shut down. Examples are inverter overload, high temperature or low battery voltage. It is therefore recommended to power the GX device from the battery.

#### Isolation

Because the CCGX is connected to many different products, please ensure that proper care is taken with isolation to prevent ground loops. In 99% of installations this will not be a problem.

- VE.Bus ports are isolated
- VE.Direct ports are isolated
- VE.Can ports are isolated
- USB ports are not isolated. Connecting a WiFi Dongle or GPS Dongle will not create a problem as it is not connected to another power supply. Even though there will be ground loop when you mount a separately-powered USB hub, during extensive testing we have not found that it caused any issues.
- The Ethernet port is isolated, except for the shield: use unshielded UTP cables for the Ethernet network.

#### Extending USB ports by use of a self-powered USB hub

Although the number of USB ports can be extended by using a hub, there is a limit to the amount of power that the *onboard USB port* can provide. When extending the number of USB ports, we recommend you always use *powered* USB hubs. And to minimize the chance of issues, be sure to use good-quality USB hubs. As Victron also offers a VE.Direct to USB adapter, you can use this arrangement to increase the number of VE.Direct devices you can connect to your system, [please see this document](#) for the limit of how many devices can be attached to various different GX devices.

#### 3.3.1. Snap-on ferrite beads for class B EMI compliance

In order to reduce Electromagnetic emissions in compliance with class B EMI you should place the provided snap-on ferrite beads around every connection cable as close as possible to the Color Control.

##### HQ1700 and later

For serial numbers HQ1700 and later, mount a single snap-on ferrite bead (supplied with the unit) around the power leads like this:



##### HQ1654 and earlier

For serial numbers HQ1654 and earlier, mount the snap-on ferrite beads as below:





### 3.4. Relay connections

The Color Control GX has potential-free Normally Open (NO) relay functionality. The function of the relay can be set via the GX menu, Settings → Relay → Function.

In addition to manual and [temperature \[56\]](#)-related triggering, it can also be used as an [alarm \[45\]](#), [generator start/stop \[113\]](#) or [tank pump \[45\]](#) relay.



If the relay function is configured as an Alarm relay, it is possible to reverse the polarity of the relay via an additional menu. The default setting is Normally open. Please note that reversing the polarity to Normally closed will result in a slightly higher current consumption of the GX device.

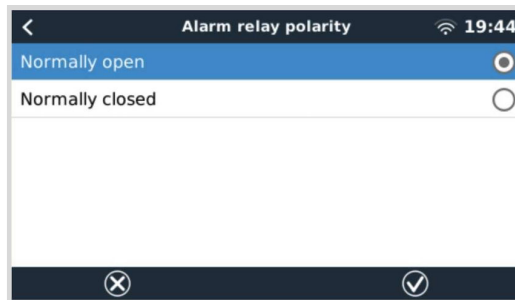
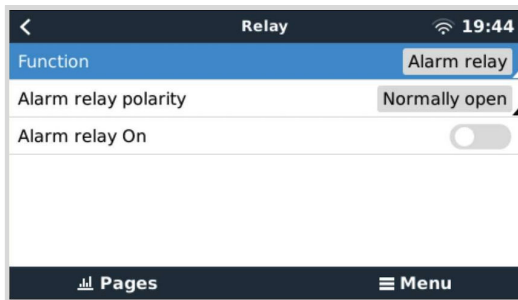

## 4. Connecting Victron products

### 4.1. VE.Bus Multis/Quattros/Inverters

In order to keep this document short we are going to refer to all Multis, Quattros and Inverters as *VE.Bus* products.

The earliest version of VE.Bus devices that can be connected using the Products: Product\_Acronym is 19xx111, where the first 2 digits represent the microprocessor and the last 3 digits represent the VE.Bus firmware version.

VE.Bus device microprocessor	GX device support
18xxxxxx	No
19xx111	Yes
20xx111	Yes
26xxxxxx	Yes
27xxxxxx	Yes

Note that for Multis, Quattros and EasySolars, it is not possible to use the Remote On/Off (header on the VE.Bus control PCB) in combination with a CCGX. There should be a wire between the left and middle terminal, as it is when shipped from the factory. In case a wired switch that disables the system is required, use the [Safety Switch Assistant](#) instead.

This limitation does not apply to the next generation of VE.Bus inverterchargers: when using a MultiPlus-II, Quattro-II or EasySolar-II, the Remote on/off terminal header \*can\* be used in combination with Color Control GX.



**Before connecting any VE.Bus product, be very careful not to confuse the GX device VE.Bus ports with the Ethernet or VE.Can/BMS-Can port!**

#### Single VE.Bus products

To connect a single VE.Bus product, connect it to one of the VE.Bus sockets on the back of the CCGX. Both sockets are identical, use either one. Use a standard RJ45 UTP cable, see our [pricelist](#).

#### Parallel, split- and three-phase VE.Bus systems

To connect multiple VE.Bus products, configured as a parallel, split-phase or three-phase VE.Bus system, connect either the first or the last VE.Bus product in the chain to either one of the VE.Bus sockets on the back of the CCGX. Use a standard RJ45 UTP cable, see our [pricelist](#).

Systems consisting of five or more VE.Bus products, connected to a CCGX with serial number HQ1628 or earlier require the [CCGX dongle for large VE.Bus systems](#) (Product Number: BPP900300100).

#### VE.Bus systems with Lithium batteries and a VE.Bus BMS

- The following only applies to the VE.Bus BMS v1, not to be confused with its successor VE.Bus BMS V2.
- Connect the CCGX to the socket labelled 'MultiPlus/Quattro', or to one of the Multis/Quattros in the system. Do not connect it to the *Remote panel* socket on the VE.Bus BMS.
- Note that it will not be possible to control the On/Off/Charger Only switch. This option is automatically disabled in the CCGX menu when a VE.Bus BMS is used. The only way to control a Multi or Quattro when used with a VE.Bus BMS is to add a Digital Multi Control to the system. Setting the input current limit is possible in systems with a VE.Bus BMS.
- Combining MultiPlus/Quattro with a VE.Bus BMS and a Digital Multi Control is possible. Simply connect the Digital Multi Control to the RJ-45 socket on the VE.Bus BMS labelled *Remote panel*.
- To allow auto-power-down in the CCGX in case of a low battery, make sure the CCGX is powered via the VE.Bus BMS: connect *Power in V+* on the CCGX to *Load disconnect* on the VE.Bus BMS. And connect both negative leads to the negative stub of a common Battery.

#### Combining the CCGX with a Digital Multi Control

It is possible to connect both a CCGX and a Digital Multi Control to a VE.Bus system. The ability to switch the product On, Off or set it to Charger Only via the CCGX will be disabled. The same applies to the input current limit: when there is a Digital Multi Control in the system, the input current limit which is set at that control panel will be the master-setting, and changing it on the CCGX will not be possible.

### Connecting multiple VE.Bus systems to a single CCGX

Only one VE.Bus system can be connected to the VE.Bus ports on the back of the CCGX. The professional way to monitor more systems is to add a second CCGX

If you do require to connect more than one system to the same CCGX, use an MK3-USB. Functionality will be limited:

- Only the system connected to the built-in VE.Bus ports is used to generate the data on the Overview pages.
- All connected systems will be visible on the Device List.
- All connected systems will be taken into account for Energy consumption and distribution calculations (kWh graphs on VRM).
- Only the system connected to the built-in VE.Bus ports is used for the Generator start/stop logic.
- Only the Multi/Quattro (which can be a single device, or multiple together configured for three-/split-phase as well as parallel) connected to the VE.Bus port will be controlled via DVCC. Additional systems, connected to the GX device using an MK3-USB, are not controlled by DVCC and will charge and discharge according to the configuration made in those units.
- The CCGX will not send proper data to VRM any more. The Venus GX does send information of both systems to VRM: its therefor better to use a Venus GX for systems like this.
- In case of an ESS system, only the system connected to the built-in VE.Bus ports is used in the ESS mechanisms. The other one is displayed in the Device List only.

Alternatively the VE.Bus to VE.Can interface (ASS030520105) can be used. Add one for each additional system. Note that we advise against it; this interface is a deprecated product. Make sure that the VE.Can network is terminated and powered. For powering the VE.Can network, see Q17 in our [data communication whitepaper](#).

### Additional features provided by a GX device to VE.Bus products

An internet connected GX device allows for remote configuration via the VRM Portal. Please read the [Remote VE.Configure manual](#) for more information, system requirements and specific steps to access this feature.

The internet connected GX device also allows remotely updating the firmware of VE.Bus products. For details see the [Remote VE.Bus firmware updates manual](#).

## 4.2. AC load monitoring

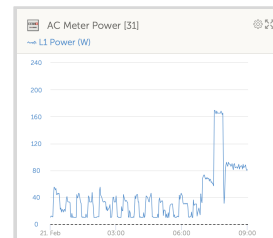
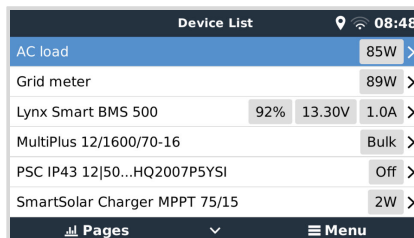
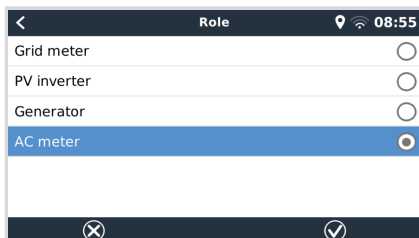

All [energy meter types](#) can be assigned the AC meter role. This is done in Settings → Energy meters → [your\_energy\_meter] → Role menu where you choose between Grid, PV Inverter, Generator and AC meter. With AC meter selected, the load will be shown in the Device list and on VRM in the advanced widgets.



Please note that such metered loads are not used in any calculations, just monitoring.

## 4.3. Battery monitors, MPPTs and Smart IP43 Chargers with a VE.Direct port

Direct connection via a [VE.Direct cable](#) is limited to the number of VE.Direct ports on the device (see [Overview of Connections \[3\]](#)). There are two types of VE.Direct cables available:

1. Straight VE.Direct cables, ASS030530xxx
2. VE.Direct cables with an angled connector on one end. These are designed to minimise the required depth behind a panel, ASS030531xxx

VE.Direct cables have a maximum length of 10 metres. It is not possible to extend them. If longer lengths are required, use a [VE.Direct to USB interface](#) with an active USB extension cable.

It is also possible to use the VE.Direct to VE.Can interface, but note that this only works for BMV-700 and BMV-702. Not for the BMV-712, MPPT solar chargers and Inverters with a VE.Direct port. See next paragraph for more information on that VE.Can interface.

### Connecting more VE.Direct devices to your Color Control GX than number of VE.Direct Ports

First of all, note that the maximum of VE.Direct devices that can be connected is GX device specific, and constrained by the CPU power. It may also be reduced for very complex systems, such as many AC PV inverters or synchronised inverter chargers, etc. So always allow some additional headroom in the design. How they are connected, whether via VE.Direct, via USB or USB hub, does not change this maximum. See the [Victron GX product range](#) for the maximum limit on all GX devices.

For the CCGX, this limit is 5.

### Options to connect more VE.Direct products than available VE.Direct ports:

1. Use the [VE.Direct to USB interface](#). The CCGX has built-in USB ports. Use a USB hub when additional USB ports are required.
2. (Only!) the BMV-700 and BMV-702 can also be connected using the VE.Direct to VE.Can interface (deprecated). Note that the BMV-712, MPPTs and VE.Direct Inverters cannot be connected using this CAN-bus interface as it does not translate their data into CAN-bus messages. When using the VE.Direct to VE.Can interface, make sure that the VE.Can network is terminated, and also powered. For powering the VE.Can network, see Q17 in [our data communication whitepaper](#). Lastly, note that this CAN-bus interface is deprecated.

### Notes about older VE.Direct MPPTs

- An MPPT 70/15 needs to be from year/week 1308 or later. Earlier 70/15s are not compatible with the CCGX, and unfortunately upgrading the MPPT firmware will not help. To find the year/week number of your model, look for the serial number which is printed on a label on its back. For example number HQ1309DER4F means 2013, week 09.

### 4.3.1. DC load monitor mode

If you wish to use a SmartShunt or BMV-712 to monitor individual DC circuits, rather than as a whole-of-system battery monitor, you can change the Monitor mode setting from Battery Monitor to DC Energy Meter in VictronConnect.

If DC meter is selected, you can then select the following types (also in VictronConnect):

Solar charger, Wind charger, Shaft generator, Alternator, Fuel cell, Water generator, DC-DC charger, AC charger, Generic source, Generic load, Electric drive, Fridge, Water pump, Bilge pump, DC system, Inverter, Water heater

Once connected to the Color Control GX, the type and the amps and power of the DC load is shown in the user interfaces and available on the VRM Portal.

When configured as type "DC System", the CCGX does more than just recording and visualisation:

1. The power shown in the DC system box is the sum of power reported by all SmartShunts configured as such. Allowing multiple meters is done to accommodate for example a catamaran, so you can measure the DC Systems on Port hull and on Starboard hull.
2. The DC system current is being compensated for when setting DVCC charge current limits to Multis, Quattros and Solar Chargers. For example when a load of 50A is being measured, and CCL by the battery is 25A, the limit given to the Multis & Solar Chargers is 75A. An improvement for systems with significant DC loads such as Yachts, Coaches and RVs.

### Notes and limitations:

- This feature is available for SmartShunts and BMV-712. Not for BMV-700 or BMV-702.
- Setting the meter mode is done with VictronConnect, in the BMV/SmartShunt itself. For details see the BMV-712 or SmartShunt product manual on the [Battery Monitor product page](#).
- The NMEA2000-out feature does not support these new types, for example when using a SmartShunt to measure output of an alternator, that data is not made available on NMEA 2000.

## 4.4. VE.Can Devices

To connect a product with a VE.Can port, use a standard [RJ45 UTP cable](#) (available with straight and elbow connectors).

Don't forget to terminate the VE.Can network at both ends using a [VE.Can terminator](#). A bag with two terminators is supplied with each VE.Can product. They are also [available separately](#).

### Other notes:

1. In order to work with the CCGX, an MPPT 150/70 must be running firmware v2.00 or newer.
2. You can combine a Skylla-i control panel with a CCGX.
3. You can combine a Ion Control panel with a CCGX.
4. All VE.Can devices power the VE.Can network, so it won't be necessary to power the VE.Can network separately in these circumstances. All the protocol converters, for example the VE.Bus to VE.Can interface and the BMV to VE.Can interface, do not power the VE.Can network.

The following VE.Can products also support VictronConnect-Remote (VC-R) – Configuration and monitoring via VRM. Please read the [VictronConnect manual](#) for further details.

VE.Can product	VC-R	Remarks
Lynx Shunt VE.Can	Yes	-
Lynx Smart BMS	Yes	-
Inverter RS, Multi RS and MPPT RS	Yes	They also have VE.Direct but must be connected via VE.Can for VC-R
Blue/Smart Solar VE.Can MPPTs <sup>[1]</sup>	Yes	Tr and MC4 models
Skylla-i and Skylla-IP44/-IP65	Yes	Requires firmware v1.11
<sup>[1]</sup> All VE.Can solar chargers except the very old (big rectangular case with display) BlueSolar MPPT VE.Can 150/70 and 150/85		

## 4.5. VE.Can Interfaces

The Color Control GX has one VE.Can interface that is electrically isolated.

VE.Can is intended to be used for Victron (and Victron compatible) VE.Can products, such as the VE.Can MPPTs, Skylla-IP65, Lynx Shunt VE.Can and Lynx Smart BMS. You can string these VE.Can 250 kbit/s devices together along this bus. It must be terminated at both ends with the included VE.Can terminators.

You can set the VE.Can port from 250 kbit/s to be 500 kbit/s (or one of several other CANbus speeds for other CANbus applications).

By default; VE.Can is set to 250 kbit/s & BMS-Can (if present) to 500 kbit/s.

Other types of Batteries and BMS may claim compatibility with BMS-Can or VE.Can, but if they are not on the [battery compatibility list](#), then they have not been tested and confirmed to work by Victron.

One extra element of possible confusion is that there are some BMS products on the market that use a CANbus-BMS profile at 250 kbit/s. These BMS products can only be connected to the VE.Can port, and it must also be set to match this (VE.Can & CAN-bus BMS (250 kbit/s)) in the services menu for the VE.Can port. They can be used in the same cable daisy chain as other Victron VE.Can devices.

## 4.6. Inverter RS, Multi RS and MPPT RS

The Inverter RS, Inverter RS Solar and Multi RS have both VE.Direct and VE.Can interfaces. For these specific products, it is only possible to connect a GX device via the VE.Can interface. It is not possible to connect a GX device via the VE.Direct interface.

The VE.Direct interface on these specific products is only used for connection of a VE.Direct to USB adapter for programming.

This restriction does not apply to the MPPT RS, which can be connected to a GX device via either VE.Direct or VE.Can.

## 4.7. BMV-600 series

- Connect the BMV-600 using the VE.Direct to BMV-60xS cable. (ASS0305322xx).

## 4.8. DC Link Box

- Connect the DC Link Box with the supplied RJ12 cable. Then connect the BMV-700 to the CCGX.

## 4.9. VE.Can Resistive Tank Sender Adapter

See the [VE.Can resistive tank sender adapter](#) product page for details about the adapter.

- To connect a product with a VE.Can port, use a [standard RJ45 UTP cable](#)
- Don't forget to terminate the VE.Can network on both ends using a [VE.Can terminator](#). A bag with two terminators is supplied with each VE.Can product. They are also [available separately](#) (ASS030700000). (Available with straight or elbow connectors).
- Make sure that the CAN-bus is powered, see the [Power chapter in the Tank Sender Adapter manual](#) for details.

## 4.10. Connecting a GX Tank 140

The GX Tank 140 is an accessory for our range of GX system monitoring products.



It takes readings from up to four tank level sensors.

Tank levels can be read-out locally in the system, as well remotely through our VRM Portal.

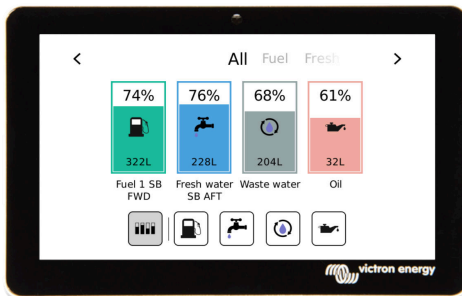

The GX Tank 140 is compatible with current senders (4 to 20mA) as well as voltage senders (0 to 10V). The connection to the GX device is via USB, which is also how the GX Tank is powered: no additional power wires required.

To make wiring the tank sender as simple as possible, two of the four inputs provide a 24V power supply, to power the sender. Using the other two channels requires an external power supply, and there is a power in terminal together with fused outputs to facilitate that.

Upper and lower limits are configurable, to allow using senders that provide only part of the scale, for example 0 to 5V.

For marine applications, the GX device can transmit these tank levels on the NMEA 2000 network to be picked up by other displays such as an MFD.

The [GX Tank 140 product page](#) links to the complete documentation of this product.

## 4.11. Victron Energy Meter VM-3P75CT

The Victron VM-3P75CT energy meter is a standard device to measure the power and energy of single- and three-phase applications, for example, at the distribution box or to measure the output of a PV Inverter, AC Genset or the output of an inverter and inverter/charger. The energy meter calculates each phase's power values and broadcasts this over VE.Can or Ethernet with a high rate.

It has built-in Ethernet and VE.Can ports for the connection to a GX device and the split-core current transformers enable easy and quick installation without modifying existing wiring. Its data is displayed on a GX device such as the [Cerbo GX](#) or [Ekrano GX](#), as well as in [VictronConnect](#) and our [VRM Portal](#).

Set up and configure the VM-3P75CT as described in the energy meter manual. When doing so, ensure the energy meter is connected to the same local network as the GX device.

The following steps are not required if the energy meter connects to the GX device via VE.Can; this is plug-and-play. If the energy meter is connected via Ethernet, it must be activated after the initial installation:

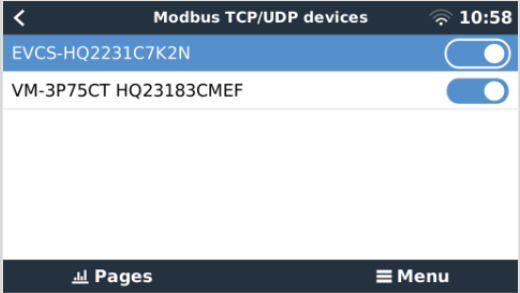
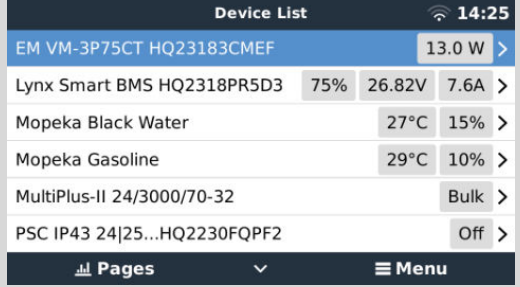

<p>In the GX device menu, go to Settings → Modbus TCP/UDP devices → Discovered devices and enable the discovered energy meter; it's disabled by default when first installed and powered.</p>	
<p>The VM-3P75CT then becomes visible in the Device List and can be monitored from there. For more details, see the energy meter manual.</p>	

## 4.12. EV Charging Station

The [EV Charging Station](#) and [EV Charging Station NS](#) with its three-phase and single-phase charging capabilities integrates seamlessly into the Victron environment with its [GX device](#) connection via WiFi and enables easy operation and control via Bluetooth and the [VictronConnect App](#).

Set up and configure the EVCS as described in the [EV Charging Station manual](#). When doing so, ensure that firstly, GX device communication is enabled and secondly, the EV charging station is connected to the same local network as the GX device.

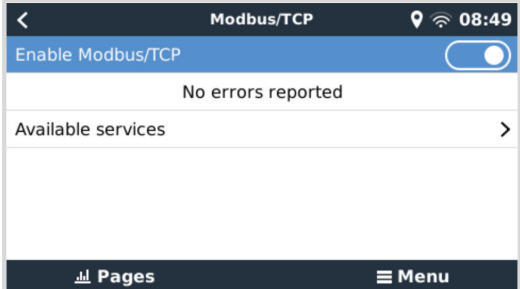
Next, Modbus TCP and the detected device must be activated on the GX device:

<p>In the GX device menu, go to Settings → Services → Modbus TCP and enable Modbus TCP.</p>	
<p>Next, go to Settings → Modbus TCP/UDP devices → Discovered devices to enable the discovered EVCS.</p> <p>Note that EV Charging Stations that were connected to the GX device prior to a GX device firmware update to 3.12 will be activated automatically. Newly added devices, however, must be activated manually via this menu.</p>	

The EVCS then becomes visible in the Device List and can be controlled and monitored from there. For more details, see the EVCS manual.

Device List				11:09
EVCS-HQ2231C7K2N	Manual	EV disconnected	>	
Lynx Smart BMS HQ2318PR5D3	81%	26.86V	2.5A	>
Mopeka Black Water		27°C	10%	>
MultiPlus-II 24/3000/70-32			Bulk	>
PSC IP43 24 25...HQ2230FQPF2			Off	>
Ruuvi Freezer		-21°C	60%	>
Pages				Menu



## 5. Connecting supported non-Victron products

### 5.1. Connecting a PV Inverter

Measuring the output of a PV Inverter will provide the user with an overview of both actual power balance and the energy distribution. Note that these measurements are only used to display information. They are not needed nor used by the installation for its performance. Besides monitoring, the GX device can also curtail some types and brands of PV Inverters, ie. reduce their output power. This is used, and required, for the [ESS Zero or limited feed-in feature](#).

#### Direct connections

Type	Zero feed-in	Details
Fronius	Yes	LAN Connection, see <a href="#">GX - GX - Fronius manual</a>
SMA	No	LAN Connection, see <a href="#">GX - GX - SMA manual</a>
SolarEdge	No	LAN Connection, see <a href="#">GX - SolarEdge manual</a>
ABB	Yes	LAN Connection, see <a href="#">GX - ABB manual</a>

#### Using a meter

For PV Inverters that cannot be interfaced digitally, a meter can be used:

Type	Zero feed-in	Details
<a href="#">AC Current Sensor</a>	No	Connected to inverter/charger analog input. Lowest cost - least accurate. <a href="#">Energy Meter</a>
<a href="#">Energy Meter</a>	No	Wired to the CCGX, or connected wirelessly using our <a href="#">Zigbee to USB/RS485 converters</a> . See the <a href="#">Energy Meters start page</a>
<a href="#">Wireless AC sensors</a>	No	See the <a href="#">Wireless AC Sensor manual</a> - Discontinued product

### 5.2. Connecting a USB GPS

Use a GPS to remotely, on the VRM Portal, track vehicles or boats. Also its possible to configure a Geofence, which will automatically send an alarm when the system leaves a designated area. And [gps-tracks.kml](#) files can be downloaded to open them e.g. in Navlink and Google Earth.

Victron does not sell USB-GPS modules, but the CCGX support third-party GPS modules which use the NMEA0183 command-set - almost all do. It can communicate at both 4800 and 38400 baud rates. Plug the unit into either of the USB sockets. Connection may take a few minutes, but the CCGX will automatically recognize the GPS. The unit's location will automatically be sent to the VRM online portal and its position is shown on the map.

The CCGX has been tested for compatibility with:

- Globalsat BU353-W SiRF STAR III 4800 baud
- Globalsat ND100 SiRF STAR III 38400 baud
- Globalsat BU353S4 SiRF STAR IV 4800 baud
- Globalsat MR350 + BR305US SiRF STAR III 4800 baud

### 5.3. Connecting a NMEA 2000 GPS

Instead of a USB GPS, a NMEA 2000 GPS can be used for remote vehicle or boat tracking in the VRM portal.

The third party NMEA 2000 GPS sender must meet the following requirements:

- The NMEA 2000 device class must be 60, Navigation.
- The NMEA 2000 device function must be 145, Ownship Position (GNSS).
- Position (latitude, longitude) must be transmitted in PGN 129025.
- Height, which is optional, must be transmitted in PGN 129029.
- Course and speed (both optional), must be transmitted in PGN 129026.

Most NMEA 2000 GPS-es are expected to work. Compatibility has been tested with:

- Garmin GPS 19X NMEA 2000

To connect a NMEA 2000 network to the VE.Can port on the GX device, which both have a different style connector, there are two solutions:

1. The [VE.Can to NMEA 2000 cable](#). Which by either inserting or leaving out the fuse allows to either power the NMEA 2000 network with Victron equipment, or not. Take note of below warning.
2. The [3802 VE.Can Adapter by OSUKL](#). Its advantage is that it lends itself well to connecting a single NMEA 2000 device such as a tank sender into a VE.Can network. It's also able to power a lower voltage NMEA 2000 network directly from a 48V Victron system.

#### Warning and solution for 24V and 48V systems

Whilst all Victron components accept up to 70V input on their CAN-bus connections, some NMEA 2000 equipment does not. They require a 12V powered NMEA 2000 connection, and sometimes work up to 30 or 36V. Make sure to check the datasheet of all used NMEA 2000 equipment. In case the system contains NMEA 2000 that requires a network voltage below the battery voltage, then either see above 3802 VE.Can Adapter by OSUKL, or alternatively install the VE.Can to NMEA 2000 cable without it's fuse, and provide suitable power to the NMEA 2000 network using for example a NMEA 2000 power adapter cable – which is not supplied by Victron. The VE.Can port on the GX device does not need external power to operate.

### 5.4. Connecting a Fischer Panda Generator

See [GX - Fischer Panda generators](#).

### 5.5. Connecting third-party NMEA 2000 tank senders

A third-party NMEA 2000 tank sender must meet the following requirements to be visible on the GX device:

- Transmit the NMEA 2000 Fluid Level PGN, 127505
- The NMEA 2000 device class needs to either General (80) in combination with function code Transducer (190), or Sensor (170). Or, the NMEA 2000 device class needs to be Sensors (75), in combination with function Fluid Level (150).

A single function reporting multiple Fluid Levels is currently not supported.

For some tank senders it is also possible to configure the capacity and the fluid type on the GX Device menus - for example the Maretron TLA100. This facility may be available with other senders made by other manufacturers - it's well-worth trying.

Tested compatible NMEA 2000 tank senders:

- Maretron TLA100
- Maretron TLM100
- Navico Fluid Level Sensor Fuel-0 PK, partno. 000-11518-001. Note that you need a Navico display to configure the Capacity, Fluid type, and other parameters of the sensor. **See voltage warning below.**
- Oceanic Systems (UK) Ltd (OSUKL) - 3271 Volumetric Tank Sender. In case it doesn't work, it needs a firmware update. Contact OSUKL for that. **See voltage warning below.**
- Oceanic Systems UK Ltd (OSUKL) - 3281 Water Level Sender. **See voltage warning below**

Most likely others work as well. If you know of one working well, get in touch with us on [Community -> Modifications](#).

To connect an NMEA 2000 network to the VE.Can port on the GX device, which both have different type connectors, there are two solutions:

1. The [VE.Can to NMEA2000 cable](#). Which by either inserting or leaving out the fuse allows to either power the NMEA 2000 network with Victron equipment, or not. Take note of below warning.
2. The [3802 VE.Can Adapter by OSUKL](#). Its advantage is that it lends itself well to connecting a single NMEA 2000 device such as a tank sender into a VE.Can network. It's also able to power a lower voltage NMEA 2000 network directly from a 48V Victron system.

**Warning and solution for 24V and 48V systems**

Whilst all Victron components accept up to 70V input on their CAN-bus connections, some NMEA 2000 equipment does not. They require a 12V powered NMEA 2000 connection, and sometimes work up to 30 or 36V. Make sure to check the datasheet of all used NMEA 2000 equipment. In case the system contains NMEA 2000 that requires a network voltage below the battery voltage, then either see above [3802 VE.Can Adapter by OSUKL](#). Or alternatively install the [VE.Can to NMEA2000 cable](#) without its fuse, and provide suitable power to the NMEA 2000 network using for example a NMEA 2000 power adapter cable – which is not supplied by Victron. The VE.Can port on the GX device does not need external power to operate.

## 5.6. Mopeka Ultrasonic Bluetooth Sensors

Mopeka sensor support has been added to Venus OS. These ultrasonic sensors use BLE (Bluetooth Low Energy). This wireless technology allows devices to be networked within a range of about 10 meters, while consuming significantly less power than ordinary Bluetooth technology.

The Mopeka sensors feature ultrasonic sensing for pressurised and non-pressurised tanks and various tank commodities. Depending on the model, the sensors are attached to the bottom or top of the tank. The liquid level, temperature and sensor battery voltage are streamed wirelessly to the GX device.

### Compatible Mopeka sensors

Mopeka sensor	Remarks
Mopeka Pro Check H2O	Requires Venus OS v3.14 minimum
Mopeka Pro Check LPG	
Mopeka Pro Check Universal	
Mopeka TD40 / TD 200	
Mopeka Pro Plus	
Mopeka Pro 200	



Only the sensors listed above are supported. Other Mopeka sensors, even if they have Bluetooth, are not supported.

To connect the Mopeka sensors to the GX device via Bluetooth, the GX device needs Bluetooth functionality. Some GX products already have built-in Bluetooth, all others can easily be retrofitted using a standard USB Bluetooth adapter (see the [Victron GX product range overview](#) for GX products that have built-in Bluetooth).

However, an additional USB Bluetooth adapter, also for GX devices with built-in Bluetooth, allows for limited relocation of the Bluetooth radio (via a USB cable extension) close to other supported Bluetooth devices that might not otherwise be reachable.

USB Bluetooth adapters that have been tested and known to work:

USB Bluetooth adapter				
Insignia (NS-PCY5BMA2)	Logilink BT0037	TP-Link UB400(UN)	Kinivo BTD-400	Ideapro USB bluetooth adapter 4.0
Ewent EW1085R4	Laird BT820	Laird BT851	-	-

A list of additional adapters that are also being tested, as well as adapters that have been tested and are known not to work, is available here: [Victron Community](#).

### 5.6.1. Installation

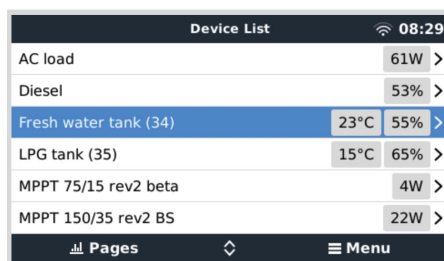
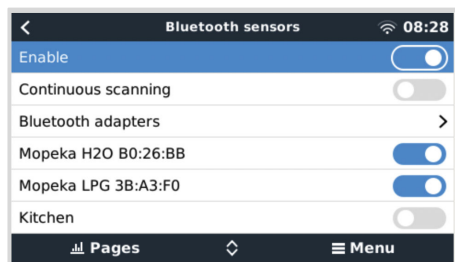

The installation of the Mopeka sensor is very simple. First, however, the sensor must be installed according to Mopeka's installation instructions and configured via the Mopeka Tank app (available in Google Play and Apple App Store). Then the installation and configuration is done in the GX device as described below.

1. Make sure Bluetooth is enabled in the Bluetooth sensors menu (enabled by default).
2. Go to Settings → I/O → Bluetooth sensors menu.
3. Move the Enable slider to the right to enable Bluetooth sensors.
4. To find your Mopeka sensor, scroll down until you see them.
5. To activate the sensor, move the slider to the right. It should now appear on the Device List.

6. Repeat steps 1..5 for more than one sensor.

## 5.6.2. Configuration

1. Go to the Device List menu.
2. Scroll up or down and select the appropriate sensor.
3. Press the right arrow key or space bar on that sensor to open up the sensor Setup menu.
4. Scroll down to Setup and right arrow key or space bar again to open up the sensors Setup menu.
5. In the Setup menu you can change the tank capacity, select the liquid type and volume unit, set up calibration values for empty and full tank levels and read the actual sensor value.
6. After setup, go back to the Sensor overview menu.
7. Scroll down, select Device and press the right arrow key or space bar again to open up the device settings menu.
8. In the Device menu you can assign a custom name to the sensor and read out some additional device information.
9. Repeat steps 1..8 if you want to set up additional sensors.

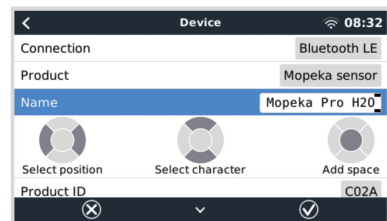
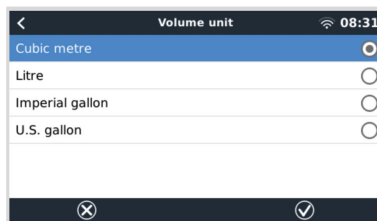
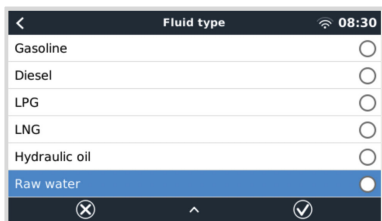
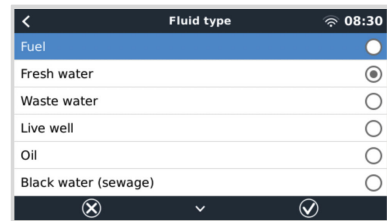
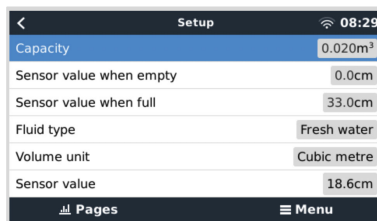
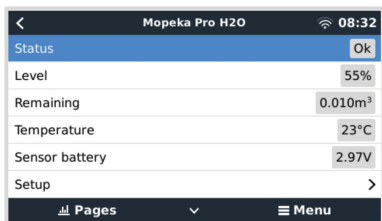

### 5.6.3. Tank level monitoring

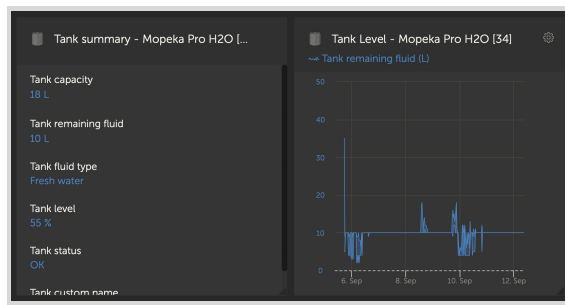
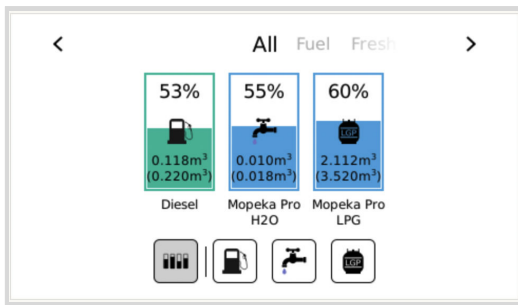

Tank levels can be monitored at various locations within the GX environment:

- Device List of the GX device
- Sensor overview menu of the GX device
- Graphical overview of the GX device
- VRM Dashboard
- VRM advanced menu widgets
- VRM App widgets

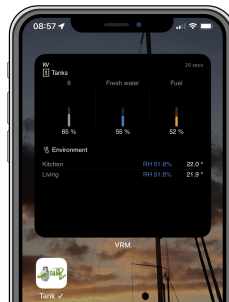
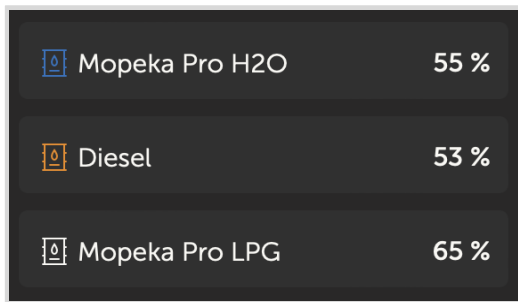

## 5.7. Wakespeed WS500 alternator regulator support

### 5.7.1. Introduction

The WS500 is an external smart alternator regulator with CAN-bus and NMEA 2000 communication, which is especially applicable in Marine and RV applications. The Wakespeed WS500 is supported by Venus OS and offers the possibility to monitor the performance of your alternators via a GX device.

### 5.7.2. Requirements

Necessary requirements for the integration of the WS500 are:

1. VenusOS firmware v2.90 or higher installed on your GX device
2. Wakespeed WS500 firmware 2.5.0 or higher installed on the WS500 controller
3. The WS500 must connect to the VE.Can port of the GX device. It is not possible to monitor the WS500 when connected to the BMS-Can port of a Cerbo GX.

### 5.7.3. Wiring the WS500 to VE.Can

Both, the WS500 and VE.Can, use RJ45 connectors for their CAN ports.

However, both have different pin outs. This means that a normal (straight UTP cable) network cable cannot be used. A crossover cable is required. This crossover cable must be made by yourself. The following diagram reflect the pin out of the two devices.

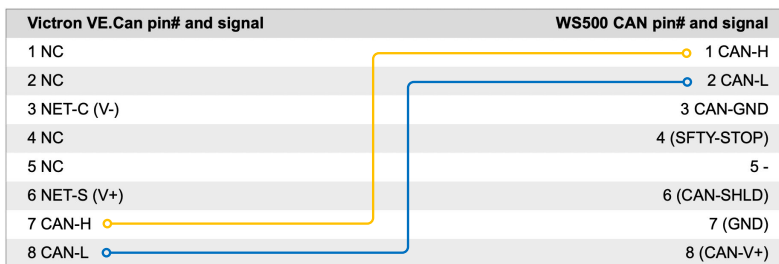

The important pins to look at are pin 7 and pin 8 for CAN-H and CAN-L on the VE.Can side and pin 1 and 2 for Can-H and CAN-L on the WS500 side.

Therefore a cable is needed where pin 1 and 2 on one side are connected to pin 7 and pin 8 on the other side. Pin 7 goes to pin 1 and pin 8 to pin 2.

The RJ45 connector with pin 7 and 8 on one end connects to the VE.Can port of the GX device. The other end of the cable with pin 1 and 2 connects to the WS500 controller. Both sides must be terminated.

The cable colors do not matter for the do-it-yourself cable. Wakespeed also offers a ready-configured cable with a blue RJ45 connector on one end that must be connected to the VE.Can port.



Please note that the black terminators supplied by Wakespeed and the blue terminators supplied by Victron are not interchangeable. Therefore: insert the Victron terminator on the Victron side of the network, and insert the Wakespeed terminator into the Wakespeed.



### 5.7.4. Wiring Example

The example below shows an overview of the recommended wiring based on an installation with a Lynx Smart BMS, Lynx Distributors and a Cerbo GX.

The correct placement of the alternator shunt (not to be confused with the shunt of the BMV or SmartShunt) is important here for the correct connection of the current sense wire.

For complete wiring between the WS500 and alternator, see the WS500 and the alternator manual.

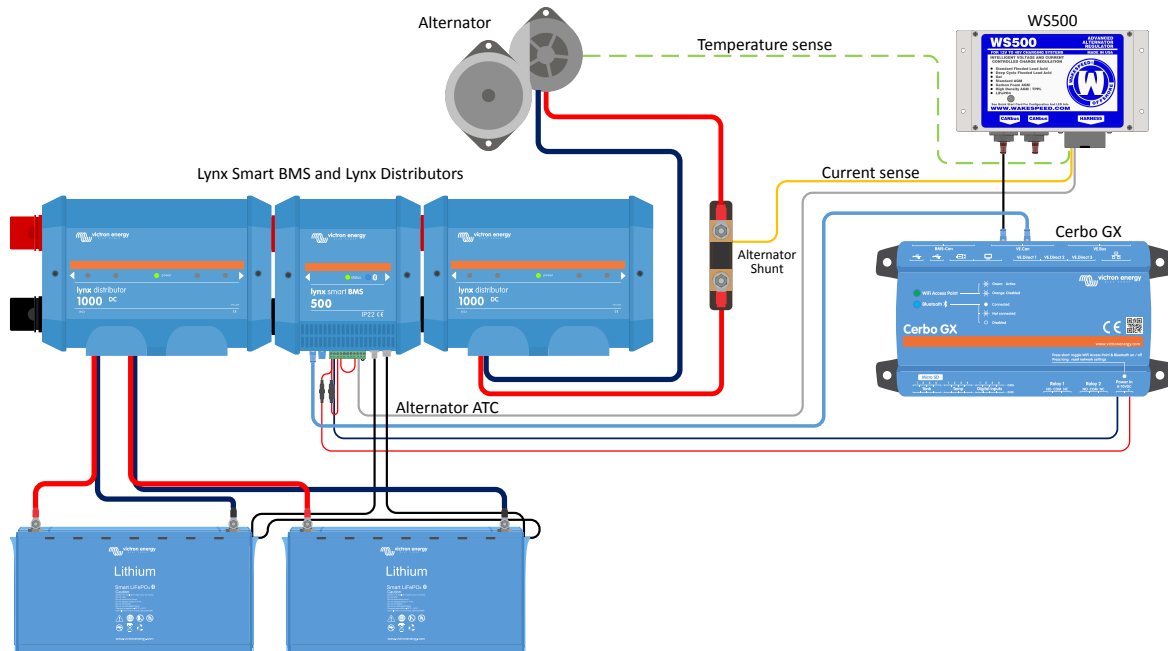

### 5.7.5. GX device user interface for WS500

Once the WS500 is connected to the GX device, the Device list contains an entry for the regulator.

The WS500 menu then provides the following information and data:

- **Output:** voltage, current and power as reported from the alternator regulator
- **Temperature:** the alternator temperature as measured by the WS500 temperature sensor
- **State:** the charging state of the WS500
  - Off when not charging
  - Bulk, Absorption or Float when the WS500 is using its own charging algorithm
  - External Control when controlled by a BMS such as Lynx Smart BMS
- **Network Status:**
  - Standalone, if the regulator is working on its own
  - Group Master, when it is supplying charging targets to another WS500 device
  - Slave, when it is taking charging directions from another device such as a WS500 or a BMS
- **Error:** reflects any error state the WS500 might be in. The details of all error codes and messages can be found in the Wakespeed Configuration and Communications guide. See also the appendix for error #91 and error #92
- **Field Drive:** report on the % of field drive being sent by the WS500 to the alternator on the field connection
- **Speed:** the speed in RPM at which the alternator is spinning. This is as reported by the stator feed and if this is wrong can be adjusted by setting the Alt Poles option within the Wakespeed SCT configuration line
- **Engine Speed:** reported in RPM. This is reported by either
  - calculation based on the alternator speed and the Eng/Alt drive ratio as set by the SCT configuration line
  - NMEA 2000, if the WS500 is receiving engine RPM from PGN127488
  - J1939, if the WS500 is receiving engine RPM from PGN61444

It is also possible to create a custom name for the WS500 in the Device menu. This triggers the WS500 to update the \$SCN configuration line of the regulator.

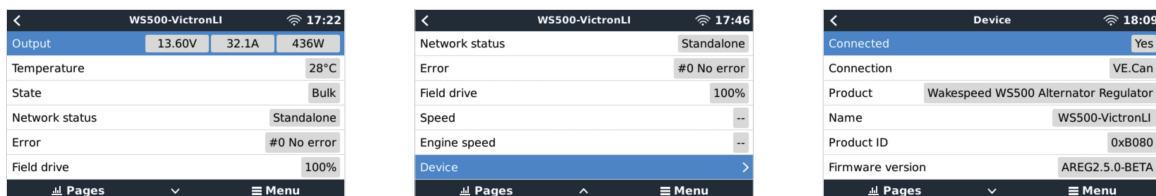

### 5.7.6. WS500 data on the VRM Portal

WS500 data that can be displayed on our [VRM portal](#) is current, voltage and temperature.

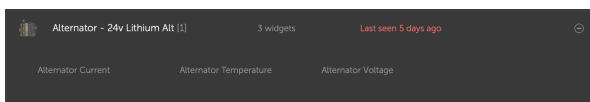

Currently 3 widgets are available on VRM

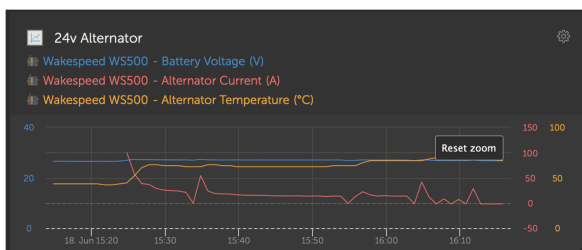

VRM custom widget showing WS500 voltage, current and temperature

### 5.7.7. Troubleshooting & FAQ

For further assistance and troubleshooting please contact Wakespeed support directly.

#### Error code #91 and #92

Venus OS will report all errors that can be generated by the WS500 as defined within the Wakespeed Communications and Configuration guide. In systems with integrated BMS, the following errors are critical as long as the events are active and require special attention.

- **#91: Lost connection with BMS**

The WS500 has lost communication with the BMS and will drop into the configured get home mode. As soon as communication is restored with the BMS, it will revert to following the charging goals as set by the BMS.

- **#92: ATC disabled through feature IN**

The BMS has signalled a charge disconnect event through the feature in wire and the WS500 has therefore reverted to an Off status.

#### Current and power data are not displayed in the WS500 device menu

This does not constitute a problem and simply relates to how the system is installed and intended to be.

- No alternator shunt<sup>[1]</sup> installed
- Alternator shunt installed but not properly configured. Check the ShuntAtBat setting and the Ignore Sensor setting using the Wakespeed configuration tools.

<sup>[1]</sup> The alternator shunt is a shunt that can be installed in series with the alternator to provide readout of alternator output current and power. Its sense wiring connects directly to the WS500. This is an optional feature that is only for display purposes. If the shunt is not installed, the GX device will show other alternator data, such as field % and output voltage etc., but not the alternator output current and power.

#### FAQ

**Q1:** Is the alternator output current (if actually measured) used for anything other than just display purposes?

**A1:** For the time being it's just for display purposes. Perhaps sometime in the future there will be DVCC integration, where the GX device controls the amount of current you want the WS500 to generate, and then the GX device splits the desired charge current between the WS500 and, for example, MPPTs.

**Q2:** What is the battery output current used for and can it be read over the canbus by a Lynx Smart BMS, other battery monitors or even a GX device?

**A2:** Yes, the current can be read out via canbus and Lynx Smart BMS.

In this case the WS500 shunt can be configured for the alternator and thus report the amount of current the alternator is producing. The Lynx Smart BMS current is used by the WS500 to ensure that no more than what the battery needs goes into the battery. So if the battery calls for 100A and the WS500 reports 200A at the alternator, 100A will be used to support the loads. It offers a greatly improved calculation for the DC load.

**Q3:** If the system includes a Lynx Smart BMS, are there any wiring recommendations?

**A3:** Yes. We have created extensive system examples that show the complete wiring and have been supplemented with important additional information. For example a catamaran system with two WS500 or a system equipped with an additional alternator controlled by one WS500. These examples can be used as a basis for your own system.

These system examples can be downloaded from the [product page of the Lynx Smart BMS](#).

**Q4:** If the system does not include a Lynx Smart BMS, how do you recommend wiring?

**A4:** Wakespeed provides a quick start guide showing how to configure the regulator via DIP switches and an overview of all wiring connections on the wiring harness that comes with the unit.

The [WS500 product manual](#) contains additional wiring diagrams that show in detail how the wiring harness is wired.

Note that the shunt should be connected to the battery and the WS500 configured with the shunt on the battery.

## 5.8. Wireless Bluetooth Ruuvi temperature sensors

The Ruuvi sensor features temperature, humidity and atmospheric pressure streamed wirelessly to the GX device via Bluetooth.

To connect the Ruuvi sensors to the GX device via Bluetooth, the GX device needs Bluetooth functionality. Some GX products already have built-in Bluetooth, all others can easily be retrofitted using a standard USB Bluetooth adapter (see the [Victron GX product range overview](#) for GX products that have built-in Bluetooth).

However, an additional USB Bluetooth adapter, also for GX devices with built-in Bluetooth, allows for limited relocation of the Bluetooth radio (via a USB cable extension) close to other supported Bluetooth devices that might not otherwise be reachable.

External USB Bluetooth adapters that have been tested and known to work:

USB Bluetooth adapter				
Insignia (NS-PCY5BMA2)	Logilink BT0037	TP-Link UB400(UN)	Kinivo BTD-400	Ideapro USB Bluetooth adapter 4.0
Ewent EW1085R4	Laird BT820	Laird BT851	-	-

A list of additional adapters that are also being tested, as well as adapters that have been tested and are known not to work, is available in [this community thread](#).

### Installation procedure

Make sure that Bluetooth is enabled in the Bluetooth menu (enabled by default).

Go to the Settings → I/O → Bluetooth sensors menu and then click Enable to enable Bluetooth temperature sensors.

The Ruuvi sensors come supplied with a removable plastic pull tab. This prevents it from discharging while on the shelf. Pull out the plastic tab and the unit will start transmitting its temperature information.



The sensor should appear in the menu, "Ruuvi ####" - with a 4 hexadecimal device ID, enable the specific Ruuvi sensor.

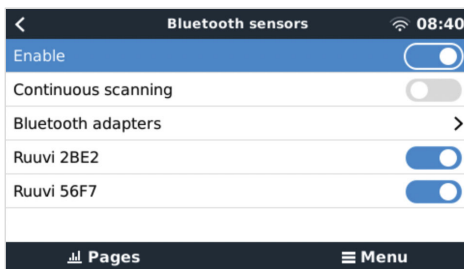

The Bluetooth adapters submenu displays a list of available Bluetooth adapters. The menu option Continuous scanning permanently scans for new Bluetooth sensors. Note that this option affects the WiFi performance of the GX device. Only enable this option if you need to search for new Bluetooth sensors. Otherwise, leave this option disabled.

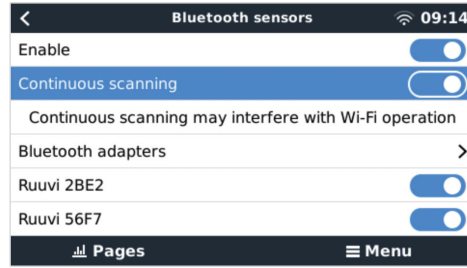
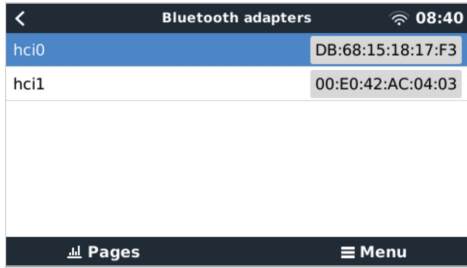

If you have multiple sensors, you may wish to physically write this device ID on the sensor case itself to help keep track. The sensor should now be visible in the main menu - by default it is labelled 'Generic temperature sensor (##)'

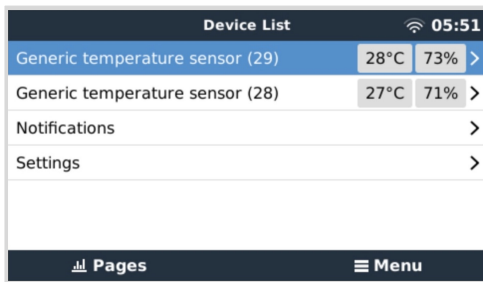

It is possible inside the temperature sensor menu to adjust the type, and also to set a custom name.

The Ruuvi sensors are estimated to last more than 12 months on a single replaceable CR2477 3V Li coin battery. Both the internal battery voltage and the battery status are displayed in the menu of the respective sensor. Status 'Ok' = battery voltage  $\leq 2.50V$ . Status 'Sensor battery low' = battery voltage  $\geq 2.50V$ .



It is possible to update the firmware for the Ruuvi with Ruuvi's own separate phone app, though this is not necessary unless you are experiencing issues.



Si-Sensor	Victron RS485 to USB interface	Signal
Black		Power Neg/Gnd - 0VDC
Black (thick)	-	Ground / Cable Shield / PE
-	Red	Power Pos - 5VDC (not used)
-	Black	Power Neg/Gnd - 0VDC (not used)
	Brown	Terminator 1 - 120R (not used)
	Green	Terminator 2 - 120R (not used)

### Installation Notes

The maximum DC power supply voltage permitted for the IMT Si-RS485 series solar irradiance sensor range is 28.0VDC - accordingly for 24V and 48V battery banks/systems an appropriate [Victron DC-DC converter](#) (24/12, 24/24, 48/12 or 48/24) or AC-DC adaptor must be utilised in the installation.

For 12V battery banks/systems the IMT Si-RS485 series solar irradiance sensor range may be powered directly from the battery bank and will continue to operate down to minimum voltage of 10.5V (as measured at the sensor, account for voltage drop in the cable).

For detailed wiring/installation notes and specifications refer to the [IMT Si-RS485 series solar irradiance sensor 'Quick Reference Guide'](#) and [Victron RS485 to USB interface cable 'Datasheet'](#).

To ensure signal integrity and robust operation, particularly ensure that;

- Extension cabling complies with the minimum cross-sectional area specifications in the related table - dependent on DC supply voltage and cable length
- Extension cabling has appropriate shielding and twisted pair cores
- The original cable attached to the Victron RS485 to USB interface is reduced to a maximum length of 20cm in installations where the total cable length is over 10m or there are installation/site specific interference issues – in this case appropriate/high quality cabling should be used for the entire cable length, rather than only for the extension length
- Cabling is installed separated/away from the main DC or AC power cabling
- All wiring is properly terminated (including unused wires) and properly isolated from weather/water ingress
- The sensor housing is not opened or tampered with during installation - as sealing integrity will be compromised (and warranty void)

The IMT Si-RS485TC series solar irradiance sensor includes internal Galvanic Isolation (up to 1000V) between power supply and RS485 Modbus circuits, accordingly the non-isolated Victron RS485 to USB interface is suitable for most installations.

However, if an isolated RS485 to USB interface is preferred the only compatible device is [Hjelmstedt Electronics USB485-STIXL](#) (any others type will not be recognised by the GX device).

### Multiple Sensors

It is possible to connect multiple IMT Si-RS485 series solar irradiance sensors to a common Victron GX device, however a dedicated Victron RS485 to USB interface is required for each individual unit.

Multiple units cannot be combined on a single interface (as this is not supported by the related Venus OS software).

### Configuration

There is normally no need for any special/additional configuration – the default 'as shipped' configuration is compatible for communication with a Victron GX device.

However, in cases where the IMT Si-RS485 series solar irradiance sensor has been previously used in another system and/or the settings changed for any reason, it is necessary to restore the default configuration before further use.

To revise the configuration, download the [IMT 'Si-MODBUS-Configuration software tool'](#). Follow the instructions in the [IMT 'Si Modbus Configurator Documentation'](#) and check/update the following settings:

- MODBUS Address: 1
- Baud Rate: 9600
- Data Format: 8N1 (10 Bit)

For further support related to configuration of the IMT Si-RS485 Series irradiance sensors please contact IMT Solar directly.

**User Interface - GX device**

Upon connection to the Victron GX device and power up the IMT Si-RS485 Series irradiance sensor will be automatically detected within a few minutes and appear in the 'Device List' menu.

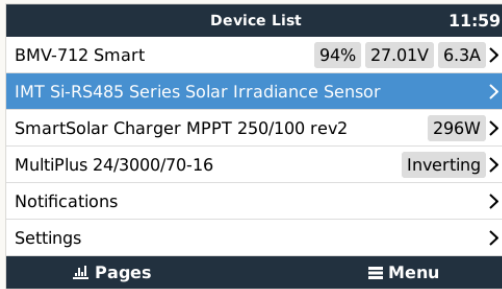

Within the 'IMT Si-RS485 Series Solar Irradiance Sensor' menu all available parameters will be automatically displayed (dependent on the sensors connected) and update in real time.

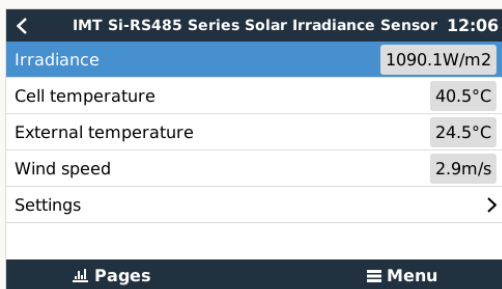

Within the 'Settings' sub-menu it is possible to manually enable and disable any optional/additional external sensors that are connected to the IMT Si-RS485 Series irradiance sensor.

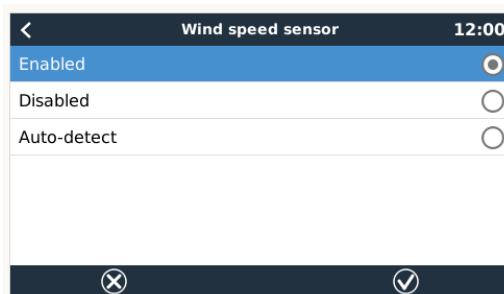
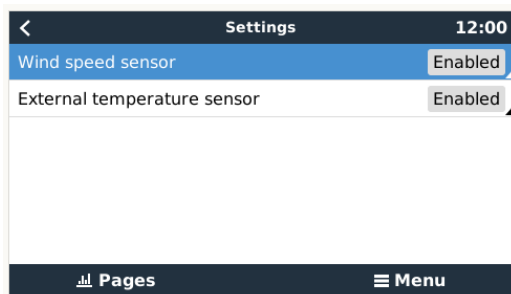



### 5.9.1. Data Visualisation - VRM

To review logged historical data on the VRM portal, expand the 'Meteorological Sensor' widget list and select the 'Meteorological Sensor' widget.

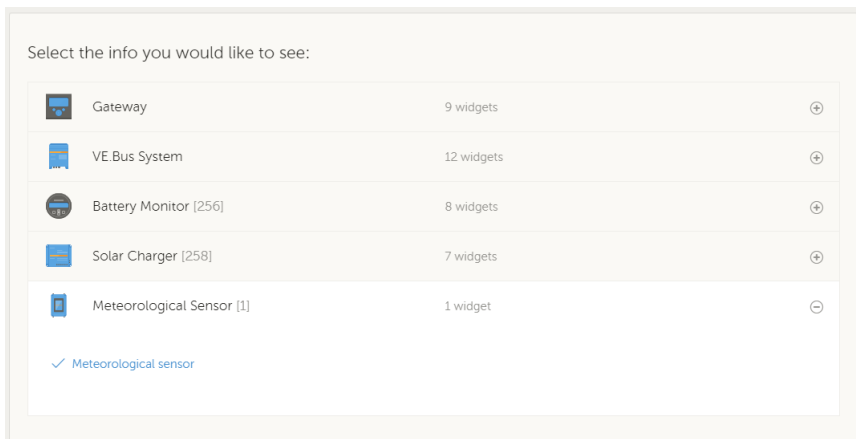

Data from all available sensor types will be automatically displayed in the graph. Individual sensors/parameters can also be disabled/enabled by clicking on the sensor name/legend.

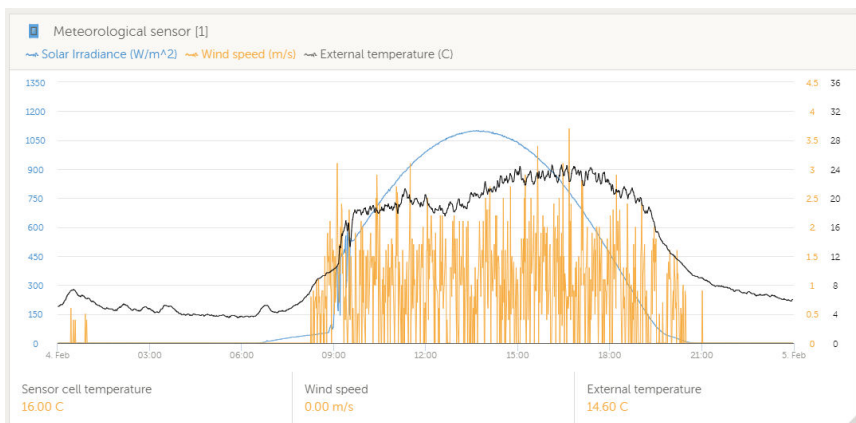

## 5.10. ComAp IntelliLite 4 series genset controller support

### 5.10.1. Introduction

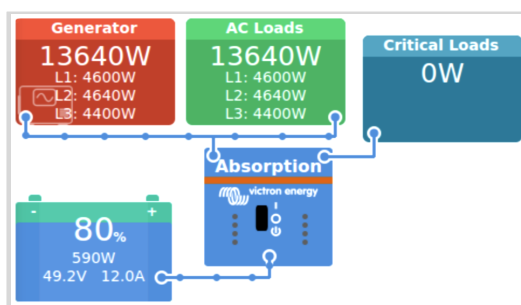

By integrating the ComAp IntelliLite 4 series genset controller with a GX device, it is possible to read out AC data, oil pressure, coolant temperature, tank level, and further status readings. In addition, it supports digital start/stop signalling from the GX device.

The following images show how the data is displayed on the GX device:

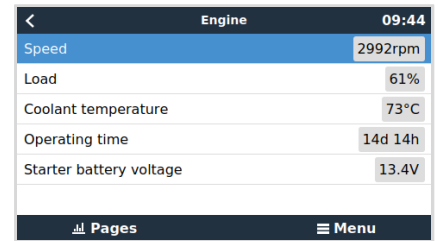
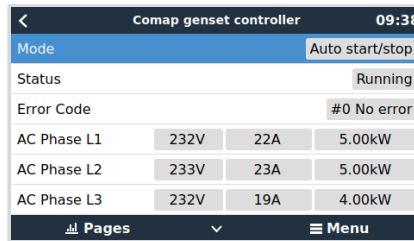
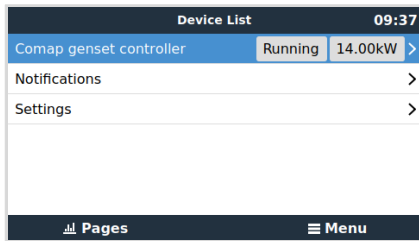

### How does it work?

The GX device reads and sends data from the IntelliLite 4 panel via Modbus, using the ComAp CM3-Ethernet module (required) as the communication interface. The default Modbus mapping of the IntelliLite 4 controller is used.

By utilising the identification string found in Modbus register 1307, the GX device automatically detects the presence of a ComAp IntelliLite 4 controller. It will detect all modules with a name starting with *IntelliLite4-*. This identification string is also shown in the title of the IntelliConfig window.



In the appendix you will find an overview of all Modbus registers used and their mappings: [Modbus holding registers for the ComAp IntelliLite 4 controller \[142\]](#).

### Supported ComAp genset controllers

The following IntelliLite 4 series genset controllers are supported:

- IntelliLite 4 AMF 25, 20, 9 and 8
- IntelliLite 4 MRS 16

### Will it work with other ComAp controllers?

It may work, but is untested. The minimum requirement is that the Modbus registers of the ComAp controller must exactly match the registers as outlined in the overview of all Modbus registers used and their mappings; see the [Modbus holding registers for the ComAp IntelliLite 4 controller \[142\]](#) in the appendix, which represent the default registers of the ComAp IntelliLite 4.

### Supported ComAp CM-Ethernet module

- CM3-Ethernet module (ComAp order code: CM3ETHERXBX)  
It may also work with the standard CM-Ethernet module (ComAp order code: CM2ETHERXBX), but has not been tested.

## 5.10.2. Installation & Configuration

Installation and configuration takes place in just a few steps. You only need to enable the Modbus Server in your CM3-Ethernet module. This can be done from the control panel or using the software for the controller, IntelliConfig, which can be downloaded from the [ComAp website](#).

No further configuration of the ComAp CM3-Ethernet module is required.

Do not change the Modbus register list in the IntelliLite 4 controller. For the GX device to be able to read the data, the ComAp Modbus register configuration needs to stay per its default settings. For the exact required configuration in the ComAp, see the appendix [Modbus holding registers for the ComAp IntelliLite 4 controller \[142\]](#)

### ComAp CM3-Ethernet configuration

The following procedure describes the steps using IntelliConfig:

1. Open the IntelliConfig app.
2. Select the Setpoint tab.
3. In the following menu, select the CM-Ethernet module.
4. Enable the Modbus server.

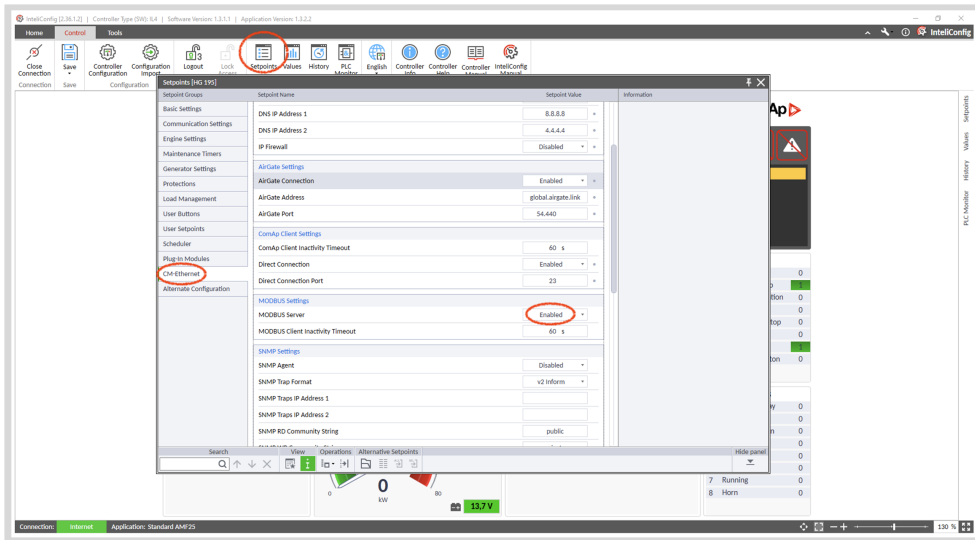

### GX device configuration

Once the GX device and the CM-Ethernet module are connected to the same network, it will automatically appear in the Device List.

If not, check the Modbus settings on the GX device, Settings → Modbus TCP Devices, and ensure Automatic scanning is enabled (default setting) or scan for it; it should be automatically detected and appear in the Discovered devices sub-menu. For this to work reliably, automatic scanning must remain switched on. The network is scanned every ten minutes. If the IP address changes, the device will be found again.

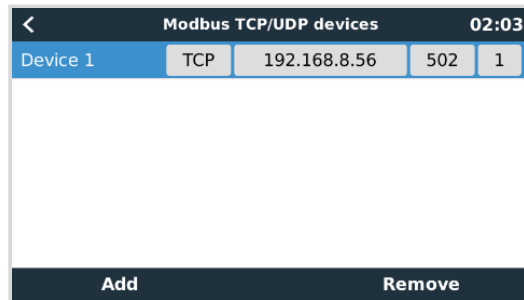
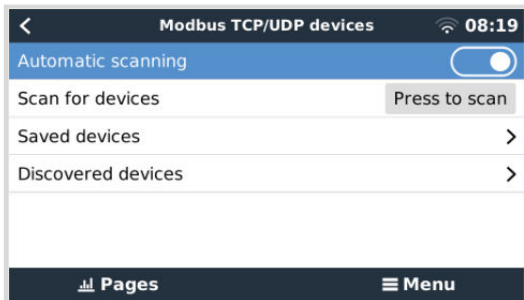

## 5.11. DSE- Deep Sea generator controller support

### 5.11.1. Introduction

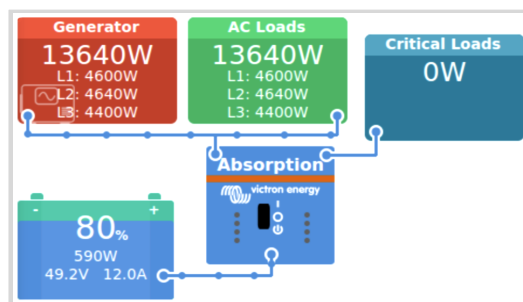

By integrating a Deep Sea Electronics (DSE) genset controller with a GX device, it is possible to read out AC data, oil pressure, coolant temperature, tank level, number of engine starts and further status readings. In addition, it supports digital start/stop signalling from the GX device.

The following images show how the data is displayed on the GX device:

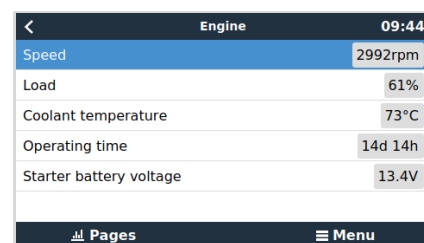
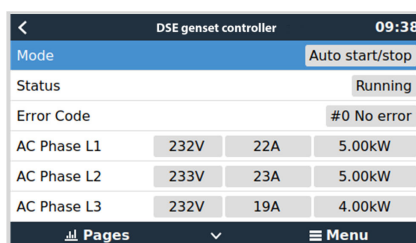
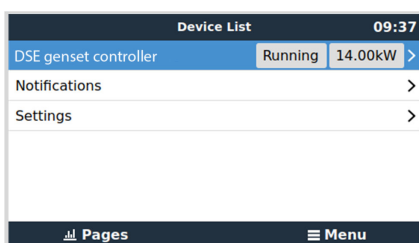

#### How does it work?

The GX device reads and sends data from the DSE controller via the Deep Sea Electronics "GenComm" Modbus specification, using either the Ethernet connection of the DSE controller itself or, for controllers without an Ethernet interface, via an USB-to-Ethernet communications device (e.g. DSE855).

By utilising the identification values found in Modbus registers 768 and 769 (GenComm Page 3, Register offsets 0 and 1), the GX device automatically detects the presence of a DSE controller.

In the appendix, you will find an overview of all Modbus registers used and their mappings: [Modbus holding registers for supported DSE genset controllers \[143\]](#).

#### Supported DSE genset controllers and DSE USB to Ethernet Communication Device

The following DSE genset controllers are supported:

DSE genset controllers	DSE USB to Ethernet Communication Device
DSE4620	DSE855 Or use the Ethernet port if one of the supported DSE controllers has it.
DSE4510 MKII	
DSE6110 MKII	
DSE7310 MKII	
DSE7410 MKII	
DSE7420 MKII	
DSE8610 MKII	
DSE8660 MKII	

#### Will it work with other DSE genset controllers?

Unfortunately it will not work with models other than the listed ones. Each model has different identification register values that need to be added manually. There is currently a [Victron community project](#) underway where you can ask if your DSE controller can be added.

### 5.11.2. Installation & Configuration

The Modbus server for the DSE855 USB to Ethernet communication device is enabled by default. The Modbus TCP port defaults to 502; don't change it. On other units, please refer to the DSE manual in case of doubt. Note that the GX device register mapping is static; it cannot be configured.

No further configuration of the DSE855 USB to Ethernet Communications Device is required.

Do not change the Modbus register list in the DSE genset controller. For the GX device to be able to read the data, the DSE controller Modbus register configuration needs to stay per its default settings. For the exact required configuration in the DSE, see the appendix [Modbus holding registers for supported DSE genset controllers \[143\]](#)

#### GX device configuration

Once the GX device and the DSE controller are connected to the same network, it will automatically appear in the Device List.

If not, check the Modbus settings on the GX device, Settings → Modbus TCP Devices, and ensure Automatic scanning is enabled (default setting) or scan for it; it should be automatically detected and appear in the Discovered devices sub-menu. For this to work reliably, automatic scanning must remain switched on. The network is scanned every ten minutes. If the IP address changes, the device will be found again.

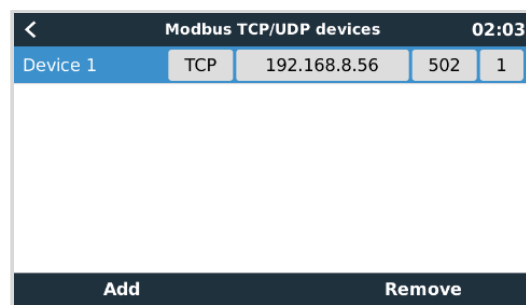
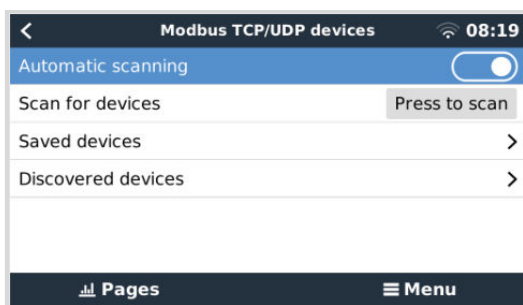

## 5.12. Reading generic alternator data from compatible NMEA 2000 DC sensors

Venus OS supports NMEA 2000 DC sensors that can be used to read alternator voltage, current and temperature from a generic alternator. Please note that the data is only displayed. They are not used for further calculations or functions.

The third-party NMEA 2000 DC sensors must meet the following requirements:

- The NMEA 2000 device class must be 35 Electrical Generation.
- The NMEA 2000 device function must be 141 DC Generator.
- DC type must be set to alternator in PGN 127506 DC Details.
- Voltage, current and temperature must be transmitted in PGN 127508 Battery Status.

Most NMEA 2000 DC sensors are expected to work.

Compatibility has been tested with:

- [Across Ocean Systems DC Current Sensors](#)

To connect a NMEA 2000 network to the VE.Can port on the GX device, which both have a different style connector, there are two solutions:

1. The [VE.Can to NMEA 2000 cable](#): By either inserting or leaving out the fuse, it allows to power the NMEA 2000 network with Victron equipment or not. Take note of the below warning.
2. The [3802 VE.Can Adapter by OSUKL](#). Its advantage is that it lends itself well to connecting a single NMEA 2000 device such as a tank sender into a VE.Can network. It's also able to power a lower voltage NMEA 2000 network directly from a 48V Victron system.

### Warning and solution for 24V and 48V systems

Whilst all Victron components accept up to 70V input on their CAN-bus connections, some NMEA 2000 equipment does not. They require a 12V powered NMEA 2000 connection, and sometimes work up to 30 or 36V. Make sure to check the datasheet of all used NMEA 2000 equipment. In case the system contains NMEA 2000 that requires a network voltage below the battery voltage, then either see above [3802 VE.Can Adapter by OSUKL](#), or alternatively install the [VE.Can to NMEA 2000 cable](#) without it's fuse, and provide suitable power to the NMEA 2000 network using for example a NMEA 2000 power adapter cable – which is not supplied by Victron. The VE.Can port on the GX device does not need external power to operate.

## 6. Internet connectivity

Connect the Color Control GX to the internet to get all the advantages of the [VRM Portal](#). The CCGX sends data from all connected products to the VRM portal - from where you can monitor energy usage, view the current status of connected products, configure [email alarms](#) and download data in CSV and Excel formats.

To monitor this data from your smartphone or tablet download the [iOS](#) or [Android VRM App](#).

In addition to remote monitoring, an active internet connection allows the CCGX to regularly check for a new firmware versions - which (depending on the setting) will be automatically downloaded and installed.

There are several ways to connect a CCGX to the internet:

- Run a network cable between a router and the CCGX Ethernet LAN port
- Connect to a router wirelessly using a USB Wi-Fi dongle plugged into the CCGX
- Via a mobile (cellular) network, using the [GX LTE 4G - a cellular USB modem](#) or, with a 3G or 4G router
- USB Tethering via a mobile phone

This video explains how to connect LAN, WiFi and a GX GSM (also applies to GX LTE 4G):



### 6.1. Ethernet LAN port

When you connect an ethernet cable between a router and CCGX, the Settings → Ethernet page of your CCGX will confirm connection.



**Before connecting the ethernet cable, be very careful not to confuse the GX device Ethernet port with the VE.Bus or VE.Can/BMS-Can ports!**

Ethernet		23:39
State	Connected	
MAC address	90:59:AF:6A:16:EB	
IP configuration	Automatic	
IP address	192.168.003.167	
Netmask	255.255.255.000	
Gateway	192.168.003.001	

## 6.2. WiFi

The CCGX does not include built-in WiFi. Though it is possible to use a supported external USB WiFi dongle. Using WiFi it is possible to connect to WEP, WPA and WPA2 secured networks.

There are several supported USB WiFi dongles. Two of them are also available from stock at Victron Energy:

- Partno. BPP900100200 - CCGX WiFi module simple (Nano USB), small, low cost.
- Partno. BPP900200300 - [Asus USB-N14](#), slightly higher cost and also better reception than the Nano USB. Supported since software version 2.23.
- Partno. BPP900200400 - [WiFi module long range \(Netgear AC1200\)](#) - higher cost and also better reception than the Nano USB. Wireless AC, Wireless G and Wireless N; 2.4 Ghz and 5 Ghz.

WiFi modules that are no longer available but still supported are:

- Partno. BPP900200100 - [Startech USB300WN2X2D](#)
- Partno. BPP900100100 - [Zyxel NWD2105](#)
- Partno. BPP900200200 - [Gembird WNP-UA-002](#), slightly higher cost and also better reception.
- Partno. BPP900200400 - [Netgear A6210-100PES](#).

Although other WiFi dongles may work, they have not been tested and we do not offer support for other dongles.

The WiFi menu shows the available networks. When a network is selected, it is possible to fill in the password (if the password is not already known) to connect to the network. Setting up via WPS (WiFi Protected Setup) is not supported.

When the CCGX finds multiple WiFi networks of which the password is known, the strongest network is selected automatically. When the signal of the connected network becomes too weak, it will automatically switch to a stronger network - if it knows the password of that network.



WiFi is an inherently less reliable connection than a hardwired ethernet cable. It should always be a preference to connect via ethernet when possible. Signal strength should always be at least 50%.

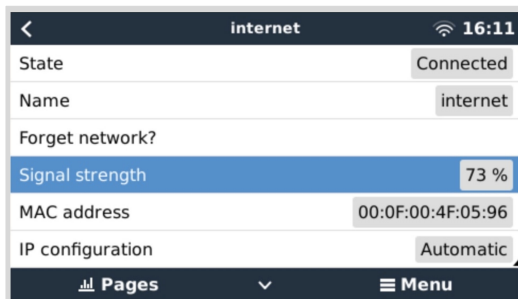

## 6.3. GX LTE 4G

The GX LTE 4G is a cellular modem for our GX range of monitoring products and provides a mobile internet connection for the system and a connection to the VRM Portal. It works on 2G, 3G and 4G networks.

Please see the [GX LTE 4G Manual](#)

## 6.4. Mobile (cellular) network using a 3G or 4G router



The GX LTE 4G provides only an internet connection for the GX device. Sharing the internet with laptops, phones, or other devices is not possible.

For installations where more devices require internet, as is often the case on a yacht or RV, or where a reliable failover/backup solution is needed, consider installing a mobile router with this functionality instead.

A mobile router can share cellular data with multiple devices such as smartphones, tablets, laptops and other devices via its Ethernet port or WiFi and is able to switch to a previously configured WiFi connection in the event of an Ethernet connection failure or vice versa.

To connect the CCGX to a mobile (cellular) network, such as a 3G or 4G network, use a cellular router. Connect the CCGX to that router with either a LAN cable or the router's WiFi network.



Make sure you use a router that is designed for unattended setups. Do not use low-cost consumer-grade routers intended for business or leisure travel. A more expensive professional router will quickly pay for itself, and you won't have wasted journeys simply to perform a reset. Examples of such professional routers are the [H685 4G LTE from Proroute](#) and the [Industrial 4G router range from Pepwave](#).

More information is in [this blog post](#).

Note that the CCGX does not support USB 3G/4G dongles, other than the [GX GSM](#) and [GX LTE 4G](#) accessories available from Victron.

## 6.5. USB tethering using a mobile phone

This is a useful facility when it works - but don't rely on it because it has not proved very dependable. Consult the internet for instructions about tethering for your phone and its particular operating system. We have heard of it working on:

- Samsung Galaxy S4

...but not on:

- iPhone 5s with iOS 8.1.1

## 6.6. Manual IP configuration

Almost no installations will need the IP address configuration to be inserted manually as most systems support automatic IP configuration (DHCP) - and that is also the CCGX default setting. If you do need to configure the address manually, select the following template:

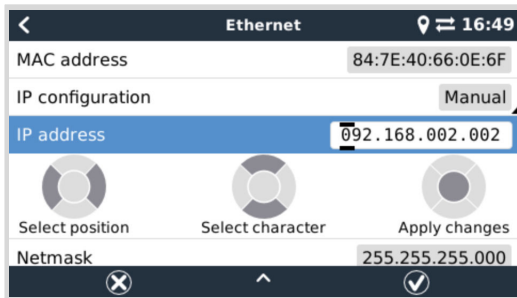

Complete details of IP requirements, as well as used port numbers will be found in the [VRM FAQ - ports and connections used by the \[127\] CCGX](#).

## 6.7. Multiple connections (failover)

It is possible to connect the CCGX to multiple networks simultaneously, Ethernet, WiFi and LTE (via a GX LTE 4G). In this case, the GX device uses Ethernet or WiFi whenever available and falls back to LTE if the Ethernet connection is lost and WiFi access isn't available.

The priority of which connection the GX device uses is based on the following order:

1. Ethernet, regardless of whether there is a WiFi or LTE connection.
2. WiFi when there is no Ethernet connection and regardless of whether there is an LTE connection.
3. LTE when there is no Ethernet and WiFi connection.



Please note that the GX device does not check whether any network devices mentioned have an active internet connection. This mechanism only considers the active network connection.

## 6.8. Minimise internet traffic

In situations where internet traffic is expensive, for example a satellite uplink or with roaming GSM/cellular charges, you may want to minimise the internet traffic. The steps to take are:

- Disable [auto firmware updates \[58\]](#)
- Do not enable [remote support \[128\]](#)
- Reduce the Log interval (Settings → VRM online portal → Log interval) to a very low frequency. Note that state changes (charging → inverting, or bulk → float) and also alarms will cause extra messages to be sent

To find out how much data allowance you need to buy the best way is to let the system run for a couple of days and monitor the internet RX and TX counters in your 3G or 4G router. Or even better, some mobile companies will report the data used via a website.

The amount of data used is also very dependent on the system:

More products connected to the CCGX will generate more data.

- A state change (from inverter to charger for example) will trigger a data transmission, so a system with very frequent state changes will also tend to generate more data. This is especially true in certain Hub-1 and Hub-2 systems.

Note that CCGX versions prior to v1.18 will check for software updates daily even when auto-update is switched off. This was changed in v1.18. Disabling auto-update also disables the check - saving a lot of data.

We recommend setting-up your data plan in such a way as to avoid costly 'excess' charges. Make sure you put a cap on your data usage; or use a pre-paid plan.

One customer - burdened with global costs of between twenty cents and several euros per mb of data - invented a clever solution: Using a VPN he modified the IP to route ALL traffic to and from the GX device via his VPN. Using a firewall at the VPN server allows him to control traffic according to time, connection type, place and destinations. Although this is beyond the scope of this manual, it works, and - with the help of a Linux and networking expert - it can work for you.

## 6.9. More information about setting up an internet connection and VRM

- [Setting up a VRM account](#)
- [VRM Portal alarms and monitoring](#)
- [VRM Portal - Frequently asked questions](#)

## 7. Accessing the GX device

It is possible to access the GX device via a smartphone, tablet or computer. This access is called Remote Console. The Remote Console is the central element for making or changing settings on the GX device.

In GX devices with a display this Remote Console feature may be disabled by default and need to be enabled. GX devices without a display have Remote Console enabled by default.

There are several ways to get access:

Access type	Color Control GX	Venus GX	Cerbo GX / Cerbo-S GX	Ekrano GX
<a href="#">VictronConnect via Bluetooth</a> <sup>[4]</sup>	- [1]	- [1]	Yes	Yes
<a href="#">Built-in WiFi Access Point</a>	- [2]	Yes	Yes	Yes
<a href="#">Local LAN/WiFi network</a> [42]	Yes	Yes	Yes	Yes
<a href="#">VRM Portal</a> [3]	Yes	Yes	Yes	Yes

[1] Both CCGX and VGX do not have built-in Bluetooth. This feature can be easily added by connecting a USB Bluetooth dongle.

[2] The CCGX does not have built-in WiFi. This feature can be easily added by attaching a USB WiFi dongle.

[3] Requires the GX device connected to the internet.

[4] GX device Bluetooth functionality is limited to assist with initial connection and networking configuration. You cannot use Bluetooth to connect to the Remote Console or other Victron products (e.g. SmartSolar charge controllers). For more information about how to connect other Victron products, please see [Connecting Victron products](#) [8].

## 7.1. Accessing the Remote Console via local LAN/WiFi Network

This section explains how to connect to Remote Console when the Color Control GX is connected to the local computer network with either an Ethernet cable, or having it configured to connect to a local WiFi network.

This method does not require an internet connection. Just a local computer network is sufficient.

Once connected, connect to the GX device by running the [VictronConnect app](#) on a phone, tablet or laptop. Note that it will need to be connected to the same computer network as the Color Control GX.

This video shows how it is done.



### 7.1.1. Alternative methods to find the IP address for Remote Console

In case VictronConnect can't be used, here are a few other methods to find the Color Control GX, ie. its IP address.

#### Link Local Address - Venus.local

When the Remote Console on LAN setting is enabled, a direct connection (via network cable without a router or DHCP server) is possible. You can access the GX device by typing `venus.local` or `http://venus.local` into a web browser, or in VictronConnect when connected to the same network. Only enable this function on trusted networks or direct connections. Make sure you have disabled the password check, or set a password first.

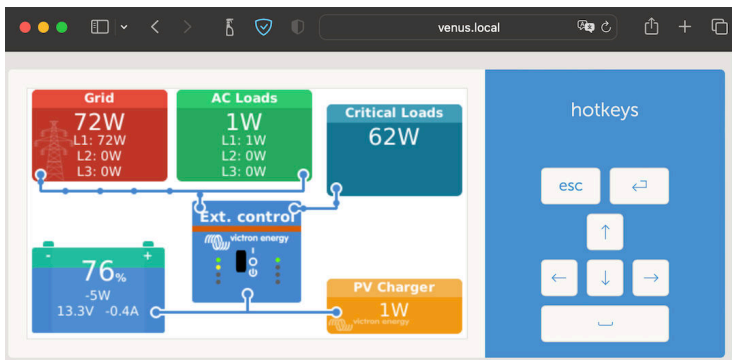

#### IP Address on VRM

On the VRM Portal, you'll find the IP address on the Device list page of the installation. Note that this does require the Color Control GX to be connected to the internet.

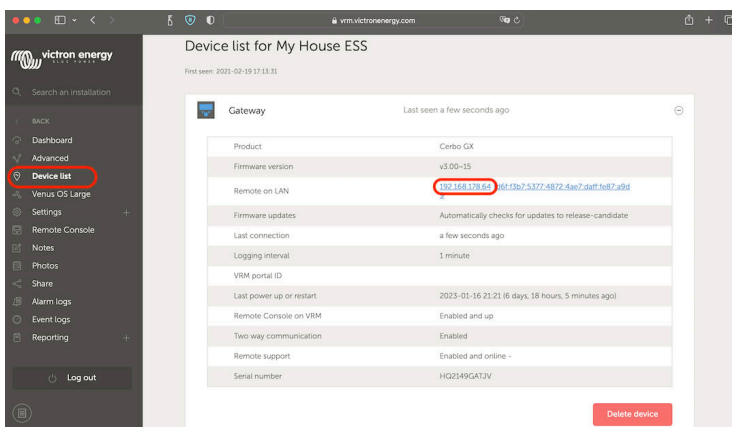

#### Network (on Microsoft Windows)

In a local network, for example at home, you can also find the Color Control GX in the Windows 'Network' overview (this uses Universal Plug-and-Play (UPnP) broadcast technology):

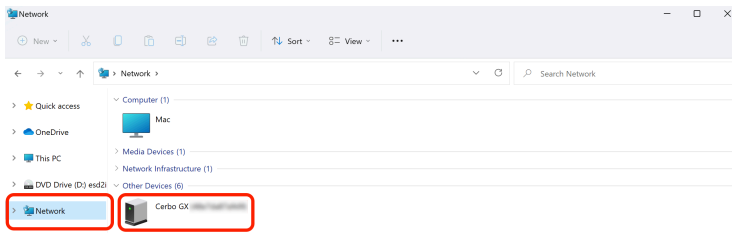

Double-clicking the icon will open up Remote Console on LAN.

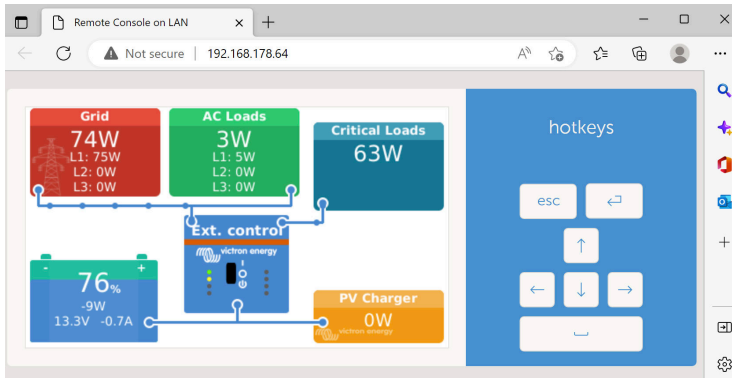

Open the 'Properties' window by right-clicking the icon to see the IP address.

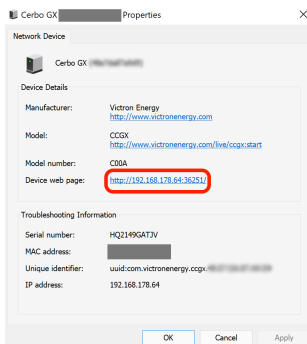

## 7.2. Accessing via VRM

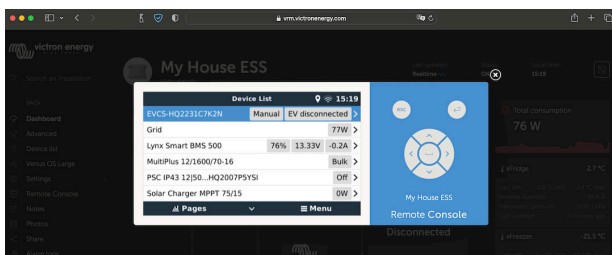

This method requires a working internet connection, both on your phone, tablet or laptop as well as for the Color Control GX. For a new install, this means that it needs to be connected by Ethernet cable.

### Step-by-step instructions:

1. First, connect the Color Control GX to the internet by plugging it into a working Ethernet network which has a DHCP server, as most networks do, and which is connected to the internet.  
The Color Control GX will immediately connect to VRM.
2. Now go to the VRM Portal, <https://vrm.victronenergy.com/>, and follow the instructions to add the device.
3. Then, once visible on VRM, click on the Remote Console link in the left-hand menu.  
The result looks similar to the image above.

More technical information in the related troubleshooting chapter: [Remote Console on VRM - Troubleshooting \[81\]](#).

### 7.3. The Remote Console menu

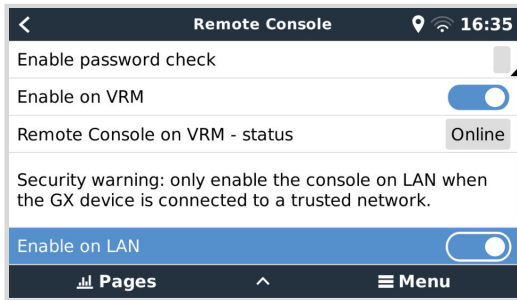

The Remote Console menu (Settings → Remote Console) contains options for controlling access to the Remote Console via LAN/WiFi and VRM and shows the online status of the Remote Console on VRM.

The options in detail:

- 1. Disable password check:**  
If this option is disabled, there is no password check when accessing the Remote Console.
- 2. Enable password check:**  
To enable password check, a password must first be assigned. Use this password when accessing the Remote Console. Keep it in a safe place.
- 3. Enable on VRM:**  
If enabled, the Remote Console can be used via the VRM portal from anywhere in the world. The password check (recommended) also applies if it is activated.
- 4. Remote Console on VRM - status:**  
Displays the online status of the Remote Console on VRM.
- 5. Enable on LAN:**  
If enabled, the Remote Console can be used via local LAN/WiFi. Mind the security warning.

Note that you need to manually reboot (Settings → General → Reboot) the GX device after changing any of these settings.

## 8. Configuration

### 8.1. Menu structure and configurable parameters

After completing the installation and setting up the internet connection (if required), go through the menu from top to bottom to configure the CCGX:

Item	Default	Description
<b>General</b>		
Access level	User and installer	Set this to 'User' to prevent accidental and unwanted changes to the configuration. Installer has additional privileges and once changed from default requires a password. Password is available from your dealer.
Remote support	No	No / Yes - Enable this to allow Victron engineers to access your system in case there is a problem.
Reboot?		Reboots the GX device
Audible alarm	Yes	When there is an alarm on the CCGX or a connected product, the CCGX will beep - unless this setting is set to 'Off'.
Demo mode	Disabled	Demonstrates product and installation features to a client or at an exhibition. This simulation mode will allow better understanding without (yet) changing any settings. Note that this will add simulated devices to a VRM installation. Demos for ESS, Boat and Motorhome are available.
<b>Firmware</b> - <a href="#">Read full feature description [58]</a>		
Firmware Version	x.xx	Displays the currently installed firmware version.
Build date/time	xxx	Displays the build number.
<div style="border: 1px solid #00a0e3; border-radius: 10px; padding: 10px; background-color: #e6f2ff;">  <p>Note that for most system applications our advise is to keep automatic updates disabled; as is also the default factory setting. Instead, update the system at a convenient moment; when people are on location and ready to revert to a previous system and/or troubleshoot in case of issues.</p> </div>		
Online updates: Auto update	Check only	If this is Enabled, the GX device will check with the server to see if there is a new version available. It is possible to set to disable, or update automatically
Online updates: Update feed	Latest release	Use the default setting unless you want to participate in test versions. End-user systems should certainly be set to 'Latest release'.
Online updates: Image type	Normal	Choice between Normal and Large image. The large image adds Node-RED and the Signal K-Server functionality to the image.
Online updates: Check for updates	Press to check	Click or press the spacebar to check if a new firmware update is available.
Install firmware from SD/USB		Use this menu to install a new version from a microSD card or USB stick. Insert the card or stick that holds the new firmware .swu file.
Stored backup firmware		With this feature you can go back to the previously installed firmware version.
<b>Date &amp; Time</b>		
Date/Time UTC	Automatic from internet	-
Date/Time local	Automatic from internet	When connected to the internet, time will be automatically synchronised regardless of this setting. Toggle this setting to manually input the time where no internet connection is present.
Time zone	Select the correct local time zone.	
<b>Remote Console</b> - <a href="#">Read full feature description [41]</a>		
Disable password check	Password authentication not required for Remote Console access.	

Item	Default	Description
Enable password check	Choose password to allow	Remote Console access.
Enable on VRM	No	No / Yes - Enabling on VRM will allow connection to the CCGX from anywhere via the VRM portal. See also <a href="#">Troubleshooting Remote Console on VRM [81]</a>
Remote Console on VRM - status	-	Displays the connection state of the VRM Remote Console Feature: Online, Offline, Disabled.
Enable on LAN	No	No / Yes - Enabling will allow direct connection to the CCGX by typing its IP address or Venus.local into a web browser, or in VictronConnect when connected to the same network. Only enable this function on trusted networks. Disable password check, or set password first.
<b>System setup</b>		
System name	Automatic	Select the system name - presets or user defined
AC input 1	Generator	Select Not available, Generator, Grid or Shore power. Note: additional configuration is required for complete setup of these options.
AC input 2	Grid	Same choices as above.
Monitor for grid failure	Disabled	Monitors for loss of AC-input and triggers an alarm if detected. Alarm is cleared when the AC-input is reconnected.
Battery monitor	Automatic	Select the SoC source. This function is useful where there is more than one BMV. Options: Automatic, No battery monitor and available battery monitor sources. For more details see <a href="#">Battery state of charge (SoC) [52]</a> .
Has DC system	Disabled	Enable this for boats, vehicles and installations with DC loads and chargers - in addition to Multi and MPPT chargers. This won't be applicable to most off-grid installations; and any discrepancy between the DC current measured by the Multi, and by the BMV, will be attributed to a 'DC system'. This may be power-in from an alternator, or power-out from a pump, for example.  A positive value indicates consumption. A negative value indicates charging, for example by an alternator.  Note that the value shown will always be an approximation, and is affected by the variation in sample rate between elements of the system.
Battery Measurements	Not set	Use this menu to define which battery measurement to see on the VRM portal and the MFD HTML5 app.
System status	On/Off	The following parameters are diagnostic flags only. See <a href="#">The System Status Menu [54]</a> chapter for details  Synchronise VE.Bus SoC with battery Use solar charger current to improve VE.Bus SoC Solar charger voltage control Solar charger current control BMS control
<b>DVCC - <a href="#">Read full feature description [67]</a></b>		
DVCC	Disabled	Enabling DVCC changes a GX device from a passive monitor into an active controller. Default setting is No, unless a compatible BMS-Can managed battery is connected, then setting is set and locked to manufacturers specification.
Limit charge current	Disabled	User-configurable system wide maximum charge current setting in Amps.
Limit managed battery charge voltage	Disabled	Only use this option for 15s Pylontech batteries on initial balancing. Using it for other purposes may have undesirable side effects.
SVS - Shared voltage sense	Disabled	The GX device automatically selects the best available voltage measurement and shares it with other connected devices.



Item	Default	Description
STS - Shared temperature sense	Disabled	The GX device will send the measured battery temperature to the inverter/charger system as well as all connected solar chargers.
Temperature sensor	Automatic	Select the temperature sensor to use for shared temperature sense measurement.
SCS - Shared current sense	No	Forwards the battery current, as measured by a battery monitor connected to the GX device, to all connected solar chargers.
Controlling BMS	Automatic	Select the BMS that controls the battery.
SCS status	-	Describes if SCS is enabled, or why it is disabled
<b>Display &amp; language</b>		
Brightness		Configure the brightness between 0 and 100%
Display off time	-	Set time-to-off between 10s / 30s - 1m / 10m /30m - or never
Show boat & motorhome overview	Disabled	Enable this to show the mobile overview page which is designed for Marine and Remote Vehicle applications. This overview gives direct access to the AC Current limit as well as the <i>On/Off/Charger-only</i> settings and pump control. Also shows up to four tank levels.
Language	English	Choose between English, Dutch, Chinese, German, Spanish, French, Italian, Swedish, Turkish, Czech, Dansk, Polish, Russian and Arabic.
Units	°C	The available options are Celsius and Fahrenheit. Please note that this setting does not affect the temperature unit in the VRM portal.
<b>VRM online portal</b> - <a href="#">Read full feature description [75]</a>		
Logging enabled	Enabled	Enable or disable logging
VRM Portal ID	-	Use this value when registering the GX device onto the VRM Portal
Log interval	15 minutes	Set to anything between 1 minute and 1 day. Choose longer times on systems with an unreliable connection. Note that this setting does not affect reporting problems and state changes (bulk → absorption) to the VRM Portal. These events initiate an immediate transmission of all parameters.
Use secure connection (HTTPS)	Yes	This encrypts the communication between the GX device and the VRM server
Last contact	-	Time since the VRM server was last contacted
Connection error	No error	Displayed if there is an error in VRM communications. <a href="#">See here for more details on troubleshooting VRM errors. [77]</a>
VRM two-way communication	Disabled	Enable for <a href="#">VRM: Remote VEConfigure</a> and <a href="#">VRM: Remote firmware update</a>
Reboot device when no contact	Disabled	The GX device will reset itself to attempt to correct a potential networking issue if the internet connection is lost for the set delay period
No contact reset delay (hh:mm)	01:00	How long the unit must be offline before restarting itself
Storage location	Internal storage	Displays if an external storage device (eg USB drive or microSD card) is mounted, or the internal storage is in use
Free disk space	-	Amount of bytes available on the storage device
microSD/USB	-	Select to safely eject an external microSD or USB storage (if one is connected) before physically removing it. Failure to do so can cause data loss.
Stored records	-	How many records are stored locally when no internet connection is available. The GX device will store as many records as it can locally, then upload them when internet is available again.
Oldest record age	-	If internet/VRM is not available, then this will display the oldest record stored on the GX device.

Item	Default	Description
<b>ESS</b> - An Energy Storage System (ESS) is a specific type of power system that integrates a power grid connection with a Victron Inverter/Charger, GX device and battery system. <a href="#">Read full feature description.</a>		
Mode	Optimized (with BatteryLife)	Optimized (with BatteryLife) and Optimized (without BatteryLife), Keep batteries charged, External control
Grid metering	-	Leave at default when there is no external Victron grid meter installed.
Inverter AC output in use	Enabled	Setting this to 'No' hides the AC-out graphic in the overview pane.
Self-consumption from battery	All system loads	This setting allows for ESS to only use battery power for essential loads. Options are 'All system loads' or 'Only critical loads'. 'Inverter AC output in use' must be enabled for this option to appear.
Multiphase regulation	-	Use the Phase compensation setting in systems with a three-phase connection to the utility grid.
Minimum SOC (unless grid fails)	10%	Configurable minimum SoC limit. ESS will supply loads from the grid once the SoC has fallen to the configured setting - except when the utility grid has failed and the system is in Inverter mode.
Active SOC limit	10%	Use this setting to see the current BatteryLife SoC level.
Peak shaving	Above minimum SoC only	Above minimum SoC only, Always
BatteryLife state	Self-Consumption	Self-consumption, Discharge disabled, Slow charge, Sustain, Recharge
Limit inverter power	Disabled	Limit the power drawn by the Multi: ie. limit the power being inverted from DC to AC.
Grid setpoint	50W	With a higher grid setpoint, you can give the system some "leeway" so as not to feed too much energy into the grid in the event of sudden load changes.
Grid feed-in	-	Set and limit grid feed-in: AC-coupled PV feed in excess, DC-coupled PV feed in excess, Limit system feed-in
Scheduled charge levels	Inactive	Allows you to set up to five scheduled periods, during which the system will take power from the grid to charge the battery.
<b>Energy meters</b> - <a href="#">Read full feature description</a>		
Role	Grid meter	Grid meter, PV inverter, Generator, AC meter
Phase type	Single phase	Either multi- or single-phase
<b>PV inverters</b> - <a href="#">Read full feature description</a>		
Inverters:	-	Shows connected AC PV inverters
Inv: Position	AC Input 1	AC input 1, AC input 2, AC Output
Inv: Phase	L1	
Inv: Show	Yes	
Find PV inverters	-	Scan for available PV inverters
Detected IP addresses	-	Shows the IP address of PV inverters that have been discovered
Add IP address manually	-	If an inverter has a manually assigned IP address, you can add it directly here.
Automatic scanning	Enabled	This setting will continue to look for PV inverters, this can be useful if using a DHCP assigned IP address that might change.
<b>Wireless AC sensors</b>		
Select the position for each AC sensor (PV Inverter on AC-input 1, 2 or on AC-output). <a href="#">More information about the Wireless AC sensors.</a>		
<b>Modbus TCP/UDP devices</b>		
Automatic scanning	Enabled	Scans automatically for Modbus TCP/UDP devices
Scan for devices	-	Manually trigger a scan for Modbus TCP/UDP devices
Saved devices	-	Displays a list of found Modbus TCP/UDP devices and their IP address

Item	Default	Description
Discovered devices	Disabled	Displays a list of discovered Modbus TCP/UDP devices. Use this menu to activate these devices.
<b>Ethernet</b> - <a href="#">read full feature description [37]</a>		
State	Unplugged	The state is either unplugged, connecting or connected
MAC address	-	
IP configuration	Automatic	Options: Automatic (DHCP) and manual IP address allocation
IP address	-	
Netmask	-	
Gateway	-	
DNS server	-	
Link-local IP address	-	
<b>WiFi</b> - <a href="#">Read full feature description [38]</a>		
Create access point	Enabled	Disables the internal WiFi access point
Wi-Fi networks	-	Displays a list of available WiFi networks and/or the network to which the GX device is connected
Name	-	SSID of the Wifi network
State	Connected	
Forget network	-	Press to "forget" the network if you want to connect to a different network or troubleshoot
Signal strength	%	
MAC address	-	
IP configuration	Automatic	Options: Automatic (DHCP) and manual IP address allocation
IP address	-	
Netmask	-	
Gateway	-	
DNS server	-	
<b>GSM modem</b> - <a href="#">Read full feature description</a>		
<b>GPS</b> - <a href="#">Read full feature description [15]</a>		
GPS information	-	Status, Latitude, Longitude, Speed, Course, Altitude, Number of satellites
Device	-	Displays device related information for diagnostic
Format	DDD.DDDDD°	Choose between decimal degrees, degrees and decimal minutes or degrees, minutes and seconds display
Speed unit	km/h	Choose between km/h, meters per second, miles per hour, or knots.
<b>Generator start/stop</b> - <a href="#">Read full feature description [113]</a>		
State	Stopped	Shows the state of the generator. Possible state messages: Stopped, Warm-up, Manually started, Running by condition, Cool-down, Stopping
Error	No error	Displays if there is an error (e.g. generator is supposed to be running but no AC input is detected)
Run time	hh:mm	The time the generator has been running since start.
Total run time	hh:mm	Total time the generator has been running since reset.
Time to service	hh	Remaining hours until the next service.
Time to next test run	hh:mm	If a periodic run is programmed, this counter will display in days, and hours how long before that will occur.
Auto start functionality	Disabled	Enable or disable the Autostart functions, this can be further configured in the Generator → Settings → Conditions menu

Item	Default	Description
Manual start	-	Start generator, Run for hh:mm
Daily run time	-	Submenu shows the history of time the generator has been running (minutes) each day for the previous 30 days.
<b>Generator start/stop → Settings</b>		
<b>Generator start/stop → Settings → Conditions</b>		
On loss of communication	Stop generator	Stop, Start, Keep generator running
Stop generator when AC input is available	Disabled	This option is ideal for backup systems where a Quattro has mains power connected to one AC input and a generator connected to the other AC input. If this option is activated, the generator will stop as soon as mains is available again.
Battery SOC	No	Use Battery SOC value to start/stop - No / Yes Start when SOC is lower than - % Start value during quiet hours - % (to override programmed quiet hours when absolutely necessary) Stop when Battery SOC is higher than - % Stop value during quiet hours - % (allows for less runtime during quiet hours, once system is recovered)
Battery current	No	Use value to start/stop - No / Yes
Battery voltage		Start when value is higher than - Amps / Voltage / Watts
AC output		Start value during quiet hours - Amps / Voltage / Watts (to override programmed quiet hours when absolutely necessary) Start after condition is reached for - seconds (to allow for momentary spikes to pass without triggering start) Stop when value is lower than - Amps / Voltage / Watts Stop value during quiet hours - Amps / Voltage / Watts (allows for less runtime during quiet hours, once system is recovered) Stop after the condition is reached for - seconds (to allow for momentary dips without stopping the running generator)
Inverter high temperature	No	Start on value warning - No / Yes
Inverter overload		Start when warning is active for - seconds (to allow for momentary spikes to pass without triggering start) When warning is cleared stop after - seconds (to allow for momentary dips without stopping the running generator)
<b>Generator start/stop → Settings → Conditions → Periodic run</b>		
Periodic run	No	Enable - No / Yes Run interval Skip run if has been running for Run interval start date Start time Run duration (hh:mm) Run until battery is fully charged
<b>Generator start/stop → Settings</b>		
Minimum run time	0	The minimum number of minutes the generator will run for any time that it is started, even after stop conditions.
Warm-up time	0	Allows a configurable time to be set for the generator to warm up or cool down via relay control while the AC input relay is open and the inverter/charger is not connected to it.
Cool-down time	0	
Detect generator at AC input	No	No / Yes - An alarm will be triggered when no power from the generator is detected at the inverter AC input. Make sure that the correct AC input is set to generator on the system setup page.
Alarm when generator is not in autostart mode	Disabled	If enabled, an alarm will be triggered when the autostart function is left disabled for more than 10 minutes.

Item	Default	Description
Quiet hours	0	Quiet hours will prevent normal generator run conditions from starting the generator. It is possible for some settings to specify override values to the quiet hours ( an extremely low battery voltage trigger to prevent a system shutdown for example)
Run time and service	Submenu	This is the service menu where the daily run time counter and service timer can be reset and the service interval hours can be defined.
Reset daily run time counters		An option to reset generator run time counters, for example if these are used for service, or if the generator is replaced or majorly repaired.
Generator total run time (hours)		The total time the generator has been running since the counter was reset.
Generator service interval (hours)		Enter the service interval in hours here.
Reset service timer		Press to reset the service timer after the service is complete.
<b>Tank pump</b> - Configure automatic starting and stopping of pump based on tank level(sender) information. <a href="#">Pump auto start/stop with Color Control GX</a>		
Pump state	-	Displays if the pump is running or not
Mode	Auto	Options are Auto, On and Off. This is the manual override to the start and stop level triggers when a tank sensor is connected.
Tank Sensor	Automatic	Select the tank sensor that is used for the tank pump trigger. 'No tank sensor' will be displayed if no tank sensor is connected or detected,
Start level	50%	The trigger point of the tank level to start the tank pump (close the relay).
Stop level	80%	The trigger point of the tank level to stop the tank pump (open the relay).
<b>Relay</b>		
Function	Alarm relay	Select the relay function. Possible functions are 'Alarm relay', 'Generator start/stop', 'Tank pump', 'Temperature', and 'Manual'.
Polarity	Normally open	Select the polarity of the relay on the back of the CCGX. 'Normally open' or 'Normally closed'. Note that setting it to Normally closed increases the CCGX power draw. This option is only available when configured as an alarm relay.
<b>Services</b>		
ModbusTCP	Off	This setting enables the ModbusTCP service. More information about <a href="#">ModbusTCP in this document</a> and in the communications white paper <a href="https://www.victronenergy.com/upload/documents/Whitepaper-Data-communication-with-Victron-Energy-products_EN.pdf">https://www.victronenergy.com/upload/documents/Whitepaper-Data-communication-with-Victron-Energy-products_EN.pdf</a>
MQTT on LAN (SSL)	On	Enables MQTT on LAN - More information on MQTT is available on <a href="#">Victron Community</a> .
MQTT on LAN (Plaintext)	Off	This setting is required to be enabled when connecting a Marine MFD
VE.Can port	VE.Can	CAN-bus profile (Disabled, VE.Can & Lynx Ion BMS 250 kbit/s, VE.Can & Can-bus BMS 250 kbit/s, CAN-bus BMS 500 kbit/s, Oceanvolt 250 kbit/s, RV-C 250 kbit/s). Additional options: Devices, NMEA2000-out, Unique identity number selector, Check unique ID numbers, Network status
CAN-bus		CAN-bus profile, Send data to VE.Can, Unique device number for VE.Can, Check unique numbers
<b>I/O</b>		

## 8.2. Battery state of charge (SoC)

### 8.2.1. Which device should I use for SoC calculation?

There are three products types that calculate state of charge (SoC). The CCGX itself does not calculate SoC, it only retrieves it from the connected devices. The three products that calculate SoC are:

1. Battery Monitors, such as the BMVs, SmartShunt, Lynx Shunt VE.Can, Lynx Smart BMS or the Lynx Ion BMS
2. Multi and Quattro inverter/chargers
3. Batteries with built-in battery monitor and a (mostly BMS-Can) connection to the CCGX.

#### When to use what?

If you have a battery with built-in battery monitor, such as a BYD or Freedomwon battery; its easy, use that. If not, then the options depend on the type of system:

1. If the MultiPlus or Quattro inverter/charger is the only source of charge to the batteries and the only draw, then it can function as a basic battery monitor because it counts what went in and counts what comes out. No need for a dedicated battery monitor such as the BMV.
2. If the systems consists of an inverter/charger, MPPTs and a **GX device**, then there is still no need to add a dedicated battery monitor.
3. For any other system types, such as a boat or RV with DC lights and other DC loads, a dedicated battery monitor will be required.

### 8.2.2. The different solutions explained in detail

#### 1. Battery and Multi or Quattro (a typical backup system)

No battery monitor is required: the Multi or Quattro is the only product connected to the battery and has full control over all charge and discharge currents. Therefore it can calculate the correct SoC itself.

Configuration:

1. Enable and configure the battery monitor in VEConfigure.
2. In the CCGX, in Settings → System setup, verify the selected battery monitor. It should be set to the Multi or Quattro.

#### 2. Battery with Multi or Quattro and MPPT Solar Chargers or a EasySolar with GX device built-in

No battery monitor is required as long as all MPPT solar chargers are Victron products and are connected to the CCGX. The CCGX will continuously read the actual charge current from all solar chargers and send the total to the Multi (or Quattro), which then uses that information in its SoC calculations.

Configuration:

1. Enable and configure the battery monitor in VEConfigure.
2. On the CCGX, in Settings → System setup, verify the selected battery monitor. It should be the Multi or Quattro.
3. In the System status menu, verify that the option 'Use solar charger current to improve VE.Bus SOC' is set to On. Note that this is not a setting - it just an indicator of an automatic process.

Note that this feature requires recent firmware versions in both the Multis or Quattros (402 minimum), and the CCGX (v2.06 minimum).

#### 3. Battery with a built-in battery monitor

In cases where the system includes a battery which has a built-in battery monitor and SoC calculation - such as many of the batteries listed [here](#) - a dedicated battery monitor is not required.

Configuration:

1. Connect the battery communications cable to the CCGX according to the instructions.
2. In the CCGX, in Settings → System setup, verify that the selected battery monitor is the battery.



Note that the battery monitor setting in VEConfigure is irrelevant. For systems like this, changing this setting will have no effect on the charge or any other parameters in this type of system.

#### 4. Other system types

When there are more chargers or loads than just the Multi or MPPT solar chargers connected to the battery, a dedicated battery monitor is required. Examples are:

- House loads in Marine or Vehicle system.
- PWM solar chargers
- AC chargers, such as Skylla-is, Phoenix Smart IP43 chargers, non Victron chargers, etc.
- Alternators
- DC-DC chargers
- Wind turbines
- Hydro turbines

In case a battery with built-in monitor is used, such as explained in (3), then that is the dedicated battery monitor. Refer to section (3). Otherwise install a BMV, SmartShunt or Lynx Shunt VE.Can.

Configuration:

1. Configure the battery monitor as per its documentation.
2. In the CCGX, in Settings → System setup, verify the selected battery monitor.
3. It should be the BMV, SmartShunt, Lynx Smart BMS or Lynx Shunt battery monitor.
4. Finished.



Note that the battery monitor setting in VEConfigure is irrelevant. For systems like this, changing this setting will have no effect on the charge or any other parameters in this type of system.

### 8.2.3. Notes on SoC

- Note that this is all about showing an accurate state of charge to the user, rather than being required for an efficient system. The SoC percentage is not used for battery charging. It is, however, required when a generator needs to be started and stopped automatically based on battery SoC.

More information:

[VRM Portal FAQ - difference between BMV SOC and VE.Bus SOC](#)

See [Configurable Parameters Section \[45\]](#) on Battery monitor selection and Has DC system.

### 8.2.4. Selecting SoC source

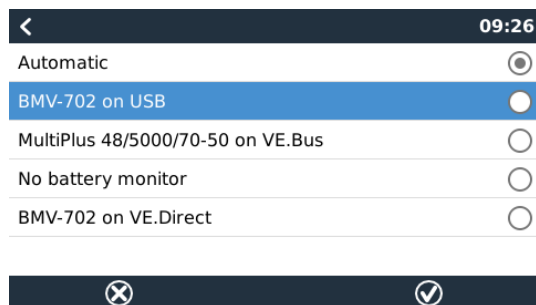

(Settings → System Setup → Battery monitor)

In the image above you can see a range of selectable choices for the SoC values which are shown in the main Overview screen. Choose the source you want to see on the main Overview screen of your CCGX.

In the same image we have chosen the Automatic setting. When automatic is selected, the System setup screen will be as shown in the image below.

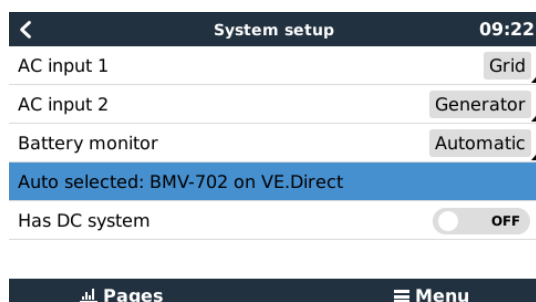

The 'Automatic' function uses the following logic:

1. When available, it will use a dedicated battery monitor, such as the BMV, SmartShunt, Lynx Smart BMS or a Lynx Shunt VE.Can, or a battery with built-in battery monitor.
2. When there is more than one of those connected, it will use a random one - although you can select one manually.
3. When there is no dedicated battery monitor, it will use the VE.Bus SoC.

#### When should I use the 'No battery monitor' option?:

Use that in systems where:

1. there is a Multi or Quattro installed
2. no BMV or other battery monitor is installed
3. the system has other DC loads or other chargers connected to the same battery, which are not connected to the CCGX.

A short explanation: The VE.Bus SoC determined by the Multi or Quattro is incorrect in the above situation as it does not take into account the discharge and charge currents by those other DC loads and also unmonitored chargers.

### 8.2.5. Details on VE.Bus SOC

- While the Inverter/Charger is in bulk, the SoC will not rise above the value as set in VEConfigure for the 'State of charge when Bulk finished' parameter on the General tab; default 85%. In a system with solar chargers, make sure that the absorption voltage as configured in the MPPT is slightly above the same setting in the inverter/charger. The latter needs to recognise that the battery voltage has reached the absorption level. If it doesn't, the SoC will be stuck at the earlier mentioned End-of-bulk percentage, default 85%.

### 8.2.6. The System Status menu

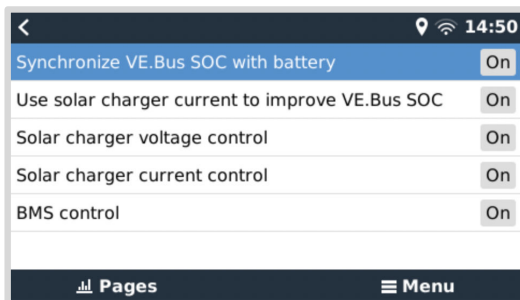

The System Status menu (Settings → System setup → System Status) contains diagnostic flags that can be useful in diagnosing problems with the system. Note that nothing can be configured here. The on/off flag depends on how a system is set up and what devices it contains.

Their meaning in detail are:

1. **Synchronise VE.Bus SoC with battery:**
  - If On, it indicates that the activated battery monitor in the Multi/Quattro is synchronising its SoC with that of a better source (a BMV or BMS in the system). The system does that automatically.
2. **Use solar charger current to improve VE.Bus SoC:**
  - In a VE.Bus system with no other battery monitor (no BMS, no SmartShunt, no managed battery) but with solar chargers, the solar charge current is taken into account and helps improve the SoC calculation of the internal Multi/Quattro battery monitor. The system does this automatically and indicates that it is active by displaying On.
3. **Solar charger voltage control:**
  - If on, this indicates that the solar chargers are not following their own internal charge algorithm. They're getting a voltage setpoint from somewhere else. Either
    - a managed battery or
    - in an ESS system, they get it from the Multi/Quattro.
4. **Solar charger current control:**
  - This indicates that the solar chargers are current limited by the system. In most cases the limiting device is a managed battery or a user-defined Maximum charge current in the DVCC menu.



5. **BMS control:**

- It indicates that the BMS is controlling the charge voltage setpoint (and not using the value set for absorption and float in the Multi/Quattro or solar charger).

### 8.3. Customise the logo on the Boat & Motorhome page

It is possible to use a custom logo on the Boat & Motorhome page.

Type the following address into the web browser of a device connected to the same network, using this address as a template: <http://venus.local/logo.php> or [http://\[ip-here\]/logo.php](http://[ip-here]/logo.php) (inserting your device's IP address between the square brackets).

The IP address can be found by going to Settings → Ethernet or WiFi. Once the page is loaded, choose an image file from your device. Reboot the GX device.

## 8.4. Temperature relay configuration

It is possible to configure the built in Relay 1, and Relay 2 (if applicable), to activate and deactivate based on temperature.

See [Connecting Temperature Sensors section](#) for compatibility and connection instructions. Confirm the temperature sensors are correctly connected and reporting temperature in the Device List.

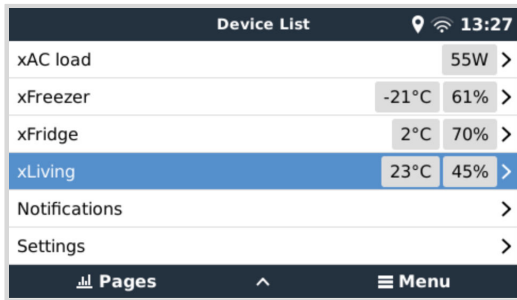

Device List		
xAC load		55W >
xFreezer	-21°C	61% >
xFridge	2°C	70% >
xLiving	23°C	45% >
Notifications		>
Settings		>

The temperature relay is controlled from Settings Menu → Relay → Function (Relay 1/2) → Temperature. Once enabled, the Temperature control rules menu will appear in the Relay menu, and inside the temperature sensors that have been detected.



Relay	
Function (Relay 1)	Generator start/stop
Function (Relay 2)	Temperature
Temperature control rules	>

Each temperature sensor can be used to control the relay. Select the temperature sensor you wish to use to control the relay. The temperature sensors that aren't used will display "No actions". It is possible to enable or disable the temperature relay control for each temperature sensor within this menu.

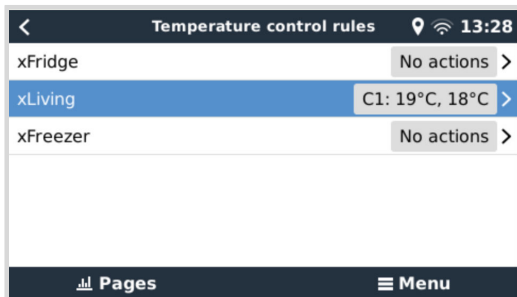

Temperature control rules	
xFridge	No actions >
xLiving	C1: 19°C, 18°C >
xFreezer	No actions >

In GX products where two relays are available (Cerbo GX & Cerbo-S GX, Ekrano GX), it is possible to have a single temperature sensor control both relays. It is also possible to have a single relay controlled by multiple different temperature sensors. For example, a Cerbo GX with 2 lithium battery heat pads, and only using both simultaneously when necessary.

1. In the Relay → Temperature control rules → Temperature sensor menu
2. Enable Relay activation on temperature
3. Assign the relay control to Relay 1
4. Set the Activation value to 5 degrees
5. Set the Deactivation value to 10 degrees

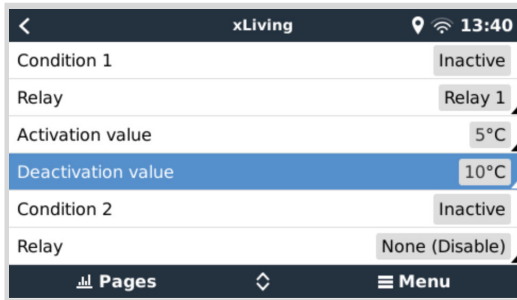

If that is insufficient to maintain the battery temperature above 5 degrees, you may wish to connect a second heat pad contactor to Relay 2 as well.

1. Move down menu to Condition 2
2. Assign the relay control to Relay 2
3. Set the Activation value to 4 degrees
4. Set the Deactivation value to 6 degrees

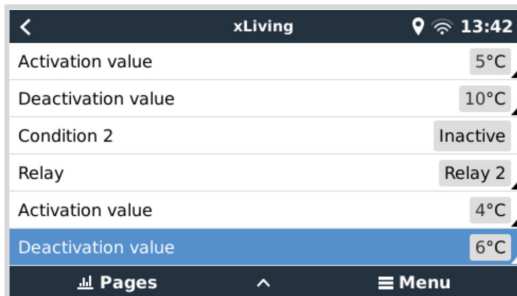

This will mean that Relay 1 will be active if the battery temperature falls to 5 degrees. If the temperature continues to fall below 5 degrees to 4 degrees, then the second heat pad will be engaged via Relay 2. If that is sufficient to raise the temperature back to 6 degrees, Relay 2 will deactivate, and then Relay 1 will remain active until battery temperature returns to 10 degrees.

Note that the physical wiring contacts are available for Relay 1 in Normally Open only.



Note the specifications for the power limits of the relays. It may be necessary to connect appliances via an additional contactor if power requirements exceed the relay power limit specification.

## 9. Firmware updates

### 9.1. Changelog

The changelog is available on [Victron Professional](#) in the Firmware → Venus OS directory. To access Victron Professional, you need to [sign up](#) (free).

### 9.2. Updating from version 1.x to 2

Running firmware version v1.74 or earlier? An upgrade is needed. Follow the [upgrade procedure to v2](#).

Otherwise follow instructions below.

### 9.3. Via internet or with microSD-card/USB-stick

There are two ways to update the firmware:

1. Update it via the internet, either manually or let it check for new updates every day.
2. Update it from a microSD-card or USB-stick.

#### 9.3.1. Direct download from the internet

On GX devices without a display (ie. a Venus GX or Cerbo GX without GX Touch), use [Remote Console](#) to get to below menus.

1. To update from the internet, navigate to: **Settings** → **Firmware** → **Online updates**.
2. Press 'Check for updates'.
3. If there is a newer firmware version, it will be shown under 'Update available'. Press to update to the new firmware version.
4. After the GX device has been updated to the new firmware version, make sure to check the settings of your installation.



Note that for most system applications our advise is to keep automatic updates disabled; as is also the default factory setting. Instead, update the system at a convenient moment; when people are on location and ready to revert to a previous system and/or troubleshoot in case of issues.

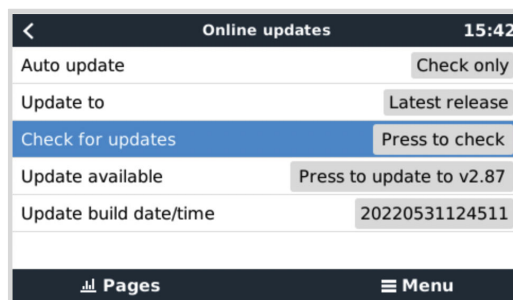
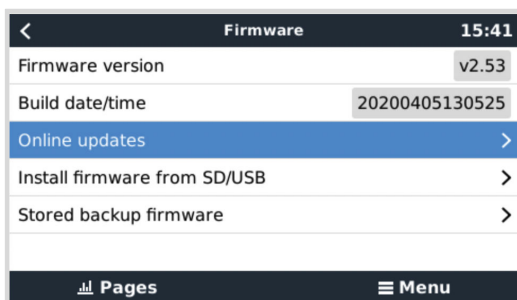

### 9.3.2. MicroSD-card or USB-stick

Updating with a microSD-card or USB-stick is called 'Offline updating'. Use it when updating a device that is not connected to the internet.

#### 1. Download the latest swu file:

Note that the same files and the changelog is available on [Victron Professional](#). There is also a Dropbox connection to connect your Dropbox to our shared folder, so you always have the latest firmware files available on your laptop.

#### 2. Install on a microSD-card or USB-stick

- Store the file in the root folder of a USB-stick or microSD-card.

#### 3. Insert the device

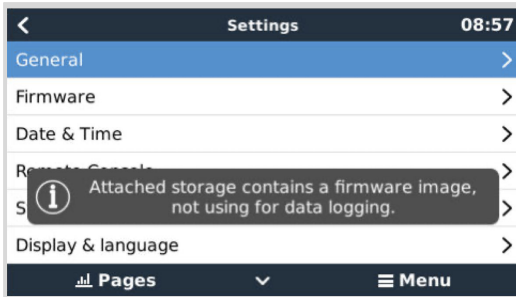

Note that you will see a warning "Attached storage contains a firmware image, not using for data logging.". That warning can safely be ignored.

#### 4. Initiate the update

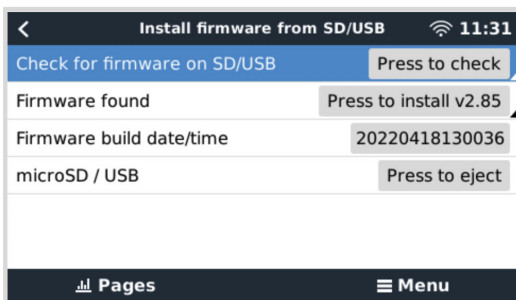

- Navigate to **Settings** → **Firmware** → **Install firmware from SD/USB**.
- Press 'Check for firmware on SD/USB'.
- If the firmware in the microSD-card or USB-stick is newer than the running one, 'Firmware found' item will appear, press it to start the update process.

## 9.4. Revert to a previous firmware version

There are two ways to revert to a previous firmware version:

1. Using the Stored firmware backup feature or
2. by downloading a specific firmware file, saving it onto a microSD-card or USB-stick and install from SD/USB.

### 9.4.1. Stored firmware backup feature

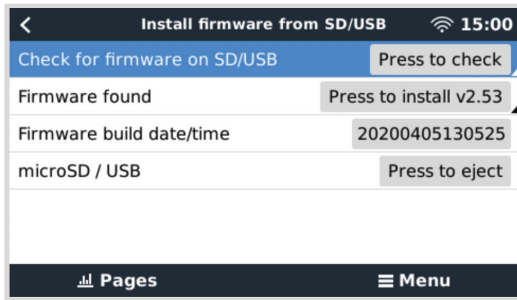

This option allows you to switch between the current and the previous firmware version. No internet or SD-card needed.

1. Go to **Settings** → **Firmware** → **Stored backup firmware**.
2. The following screen shows the firmware version currently running and the firmware version that can be booted.
3. Click on 'Press to boot' to boot into the stored firmware version.
4. The stored firmware version is now booted and the previous firmware version will be saved instead.

### 9.4.2. Install a specific firmware version from SD/USB

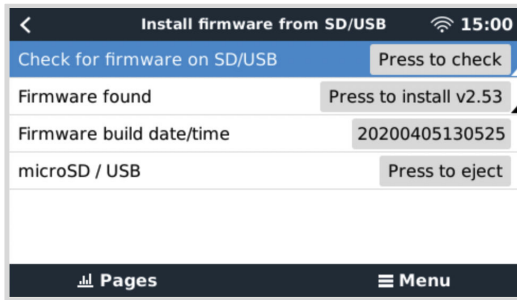

There may be reasons why it is necessary to manually download and install a specific firmware version (e.g. an older firmware version that is not stored under "Stored backup firmware" on the GX device). This chapter explains how to do that.

1. Old Venus OS firmware versions are available for download here: <https://updates.victronenergy.com/feeds/venus/release/images/>
2. For Color Control GX use the ccgx folder.
3. Download the .swu file of the version required.
4. Store the .swu file in the root folder of a USB-stick or MicroSD-card.
5. Insert the USB-stick or MicroSD-card into your GX device.
6. Note that you will see a warning "Attached storage contains a firmware image, not using for data logging.". The warning can safely be ignored.
7. Navigate to **Settings** → **Firmware** → **Install firmware from SD/USB**.
8. It should show the specific firmware version under 'Firmware found'. Click on it to install.



Note that while backporting is no problem in general, it may be that some settings are reset to their default values. Be sure to check this.

## 10. VE.Bus Inverter/charger monitoring

### 10.1. Input current-limiter setting

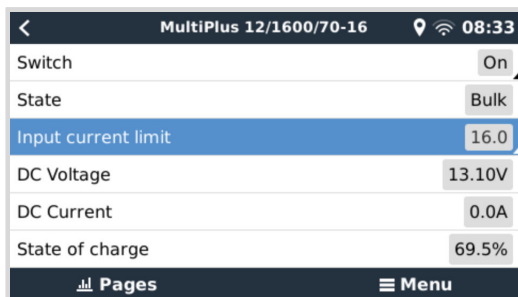

This chapter explains the implications of enabling or disabling user control of the input current-limiter setting, as seen in the above menu (Device List → [your inverter/charger]).

The limit as set by the user in the Color Control GX will be applied to all inputs where the '**Overruled by remote**' setting in VEConfigure is enabled:

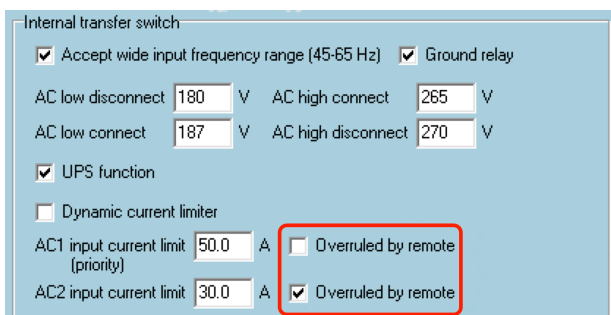

Using the example of a boat with two AC inputs and a Quattro where:

1. A Genset capable of delivering 50A is connected to input 1;
2. Shore power is connected to input 2 (available power depends on the rating of the harbour power-supply).

Configure the system exactly as in above VEConfigure screenshot. Input 1 has priority over input 2, therefore the system will automatically connect to the genset whenever it is running. The fixed input current limit of 50A will be applied. And when the genset is not available, and mains is available on input 2, the Quattro will use the input current limit as configured in the CCGX.

Two more examples: (In both cases, if you disable 'Overruled by remote', setting a current limit in the CCGX will have no effect. And if you enable 'Overrule by remote' for both inputs, the current limit set in the CCGX will be applied to both inputs.)

#### Minimum input current limit values

When PowerAssist is enabled in VEConfigure, there is a minimum input current limit. The actual limit differs for each model. After setting the input current to a value below the limit, it will automatically be increased again to the limit.

Note that it is still possible to set the input current limit to 0. When set to 0, the system will be in passthrough (charger disabled).

#### Parallel and three-phase systems

The configured AC input current limit is the total limit per phase.



## 10.2. Phase rotation warning

The AC supply, either Generator or Grid, to a three phase inverter/charger system needs to be in the correct rotation, also known as sequence. If not, then the inverter/chargers will not accept the AC supply and remain in Inverter mode.

The Phase rotation warning will be raised in such case. To resolve the issue, change the wiring on the AC input: swap either one of the phases, effectively changing the rotation from L3 → L2 → L1 to L1 → L2 → L3. Or reprogram the Multis and modify the phase assigned to match the wiring.

On the GX device itself, the warning will popup as a notification on the GUI:

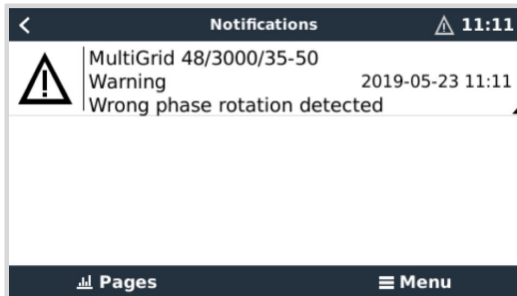

Also, it is visible in the menus:

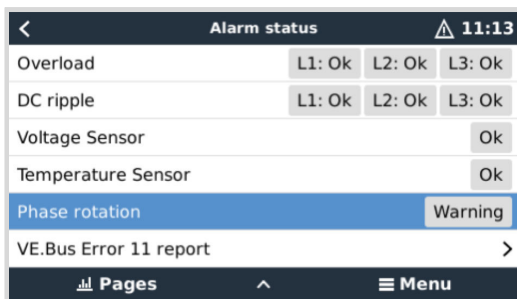

On the VRM Portal, it is visible in the VE.Bus Alarms & warnings widget on the Advanced page and will be listed in the Alarm Log on VRM. Furthermore, an email is sent; using [the VRM Alarm Monitoring system](#).

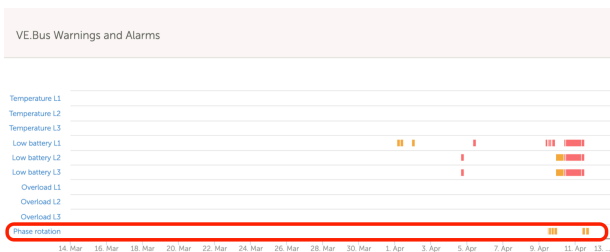

## 10.3. BMS connection lost alarm

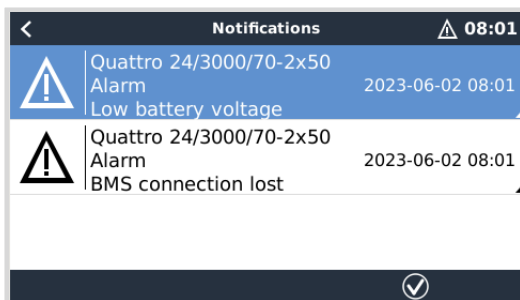

This alarm is triggered once the inverter/charger has received CVL/CCL or DCL data from a managed battery and will shut down if the battery is disconnected or communication with the battery get lost. The alarm is also raised when the inverter/charger has lost connection to a VE.Bus BMS.

Note that the system will also display a Low battery voltage alarm. However, the cause of this alarm is not a low battery voltage, but the lack of information from the battery due to lost communication.

To resolve the alarm, restore the connection with the BMS or restart/power cycle the inverter/charger. A restart can be performed from the [Advanced menu \[64\]](#) of the VE.Bus device.

## 10.4. Grid failure monitoring

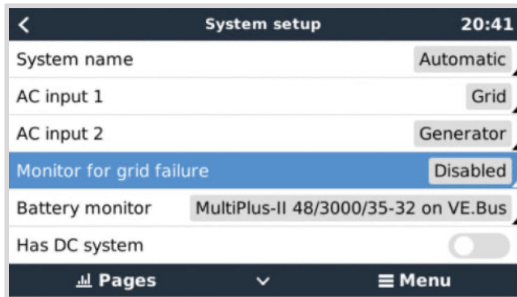

When this feature is enabled, an alarm is raised when the system hasn't been connected to the AC input configured to be Grid or Shore for more than 5 seconds.

- The alarm shows as a Notification in the GUI and as an alarm on the VRM Portal. It is also available on ModbusTCP / MQTT.
- Recommend to use for backup systems. But also for yachts or vehicles on shore power.

Note that this settings monitors that the system is connected to grid/shore. Generator monitoring is already available as part of the Generator start/stop function and not part of this.



Do not use this feature in systems that use the Ignore AC Input settings in our inverter/chargers: when the system ignores the AC input, ie. runs in island mode, as intended, even though grid is available, it will report a grid failure.

## 10.5. Advanced menu

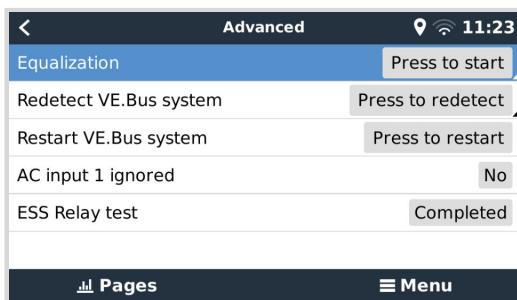

The Advanced menu can be accessed from Device List → [Multi or Quattro] → Advanced and contains options for equalisation, redetect and restart VE.Bus system and shows the ESS relay test status.

- **Equalisation:** Starts equalisation. See Multi or Quattro documentation for details.
- **Redetect VE.Bus system:** Clears the cache on the Color Control GX that has certain data of the VE.Bus system stored to keep the boot time as short as possible. Use this feature if, for example, a VE.Bus BMS used to be part of a system and is no longer used or replaced by a Lynx Smart BMS. When using Redetect VE.Bus system, the inverter/charger does not switch off for a couple of seconds like it would do when using Restart VE.Bus system.
- **Restart VE.Bus system:** Restarts the inverter/charger (just like switching it off and on again from the main rocker switch at the front) if it failed to restart automatically (after 3 attempts), for example, after a (very) heavy overload; or three overloads in a row. Any persistent errors such as a repeated and unrecoverable overload error, are deleted.
- **AC Input 1 ignored:** Status of the AC Input 1 flag
- **ESS Relay test:** Shows the status of the ESS Relay test. Only relevant when its an ESS system. See Q9 in the [ESS Manual FAQ](#) for details.

## 10.6. Alarm status monitoring

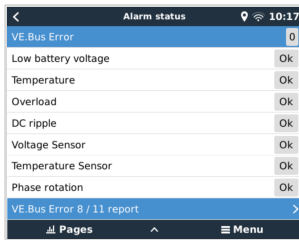

The Alarm status monitoring page can be accessed from Device List → [Multi or Quattro] → Alarm status. It displays diagnostic information on specific parameters to help with troubleshooting and provides additional information on the [VE.Bus error 8/11](#).

## 10.7. VE.Bus alarm setup menu

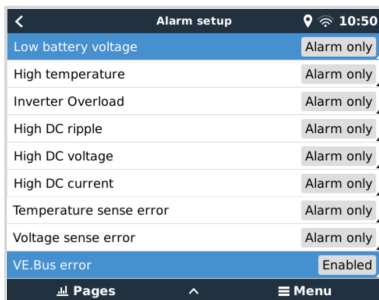

When using a VE.Bus system, it is possible to configure the severity of problems on the VE.Bus system that should cause a notification to show up on the Color Control GX (and make it beep).

To change the VE.Bus alarm & warning notifications, proceed as follows:

1. On the Remote Console, go to Device List → [your VE.Bus product] → Alarm setup
2. Choose between the following notification settings for each alarm:
  - **Disabled:** The CCGX will never beep or show a notification. Not recommended.
  - **Alarm only** (default): The CCGX will only beep and show a notification when the VE.Bus system switched off in an alarm condition. Warnings are ignored.
  - **Alarm & warnings:** The CCGX will beep and show a notification on all selected alarms and warnings.
3. Scroll to the bottom of the list and enable or disable VE.Bus error notification.

When all done, don't forget to change the access level to user when required.

## 10.8. Device menu



The Device menu (Device List → [Multi or Quattro] → Device) offers device-related parameters such as custom name setting, firmware version, serial numbers (in the sub-menu) and more that can be used for diagnostic.

## 10.9. Solar & Wind Priority

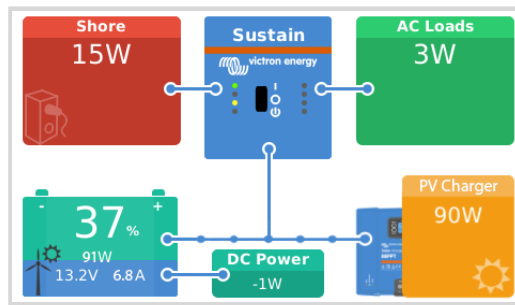

The solar and wind priority function ensures that solar and wind energy are used to charge the battery. At the same time, shore power is only used to prevent the battery from becoming too deeply discharged.

When activated, the system remains in this mode, called Sustain, for seven days; if there is not enough sun or wind, a full charge cycle will take place, charging the batteries to 100%. This ensures they remain in optimal condition and are ready for later use.

After these seven days, the system will not return to sustain mode. Instead, it will keep the batteries fully charged and prioritise solar power over shore power wherever possible during the day to run DC loads such as pumps and alarm systems.

For details and configuration, please see the [Solar & Wind Priority manual](#).

## 11. DVCC - Distributed Voltage and Current Control

### 11.1. Introduction and features

Enabling DVCC changes a GX device from a passive monitor into an active controller. The available features and effects of enabling DVCC depend on the type of battery used. The effect also depends on the installed Victron components and their configuration. Two examples:

**Managed CAN-bus batteries:** In systems with a managed CAN-bus BMS battery connected, the GX device receives a Charge Voltage Limit (CVL), Charge Current Limit (CCL) and Discharge Current Limit (DCL) from that battery and relays that to the connected inverter/chargers, solar chargers and Orion XS. These then disable their internal charging algorithms and simply do what they're told by the battery.

**Lead-acid batteries:** For systems with lead-acid batteries, DVCC offers features such as a configurable system-wide charge current limit, where the GX device actively limits the inverter/charger if the solar chargers are already charging at full power, as well as Shared Temperature Sense (STS) and Shared Current Sense (SCS).

This table shows the recommended settings for different battery types:

	Lead-acid	VE.Bus BMS V1 Lithium	VE.Bus BMS V2 <sup>1)</sup> Lithium	Supported 3rd party managed batteries <sup>2)</sup>
Auto-config	No	No	No	2)
System charge current	Yes	Yes	Yes	2)
Should you enable SVS?	Yes	3), 4)	3), 4)	2)
Should you enable STS?	Yes	No	No	2)
Should you enable SCS	Yes	3), 4)	3), 4)	2)
Charge control method	N/A	N/A	N/A	2)
Wire ATC & ATD	N/A	Yes	5)	2)

<sup>1)</sup> DVCC must be enabled for the GX device to control the solar chargers, Inverter RS or Multi RS in a system with a VE.Bus BMS V2.

<sup>2)</sup> Use the [Battery Compatibility manual](#) to see which parameters need to be set and which are set automatically.

<sup>3)</sup> In an ESS system the VE.Bus device is already synced with the solar chargers, so we recommend leaving SVS and SCS off.

<sup>4)</sup> For all other systems: If a BMV or SmartShunt is installed, we recommend enabling SVS and SCS. In all other cases, leave SVS and SCS disabled.

<sup>5)</sup> Solar Chargers, Inverter/Chargers, Multi RS, Inverter RS and Orion XS do not require wiring. All other loads and chargers must be wired and controlled via ATC/ATD.

To enable or disable DVCC, go to Settings → DVCC on the GX device:

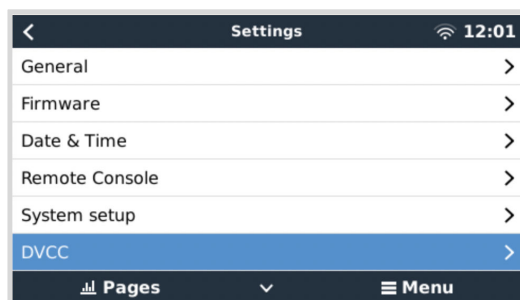

## 11.2. DVCC Requirements

### 1. Battery compatibility

- For CAN-bus connected batteries, check the relevant page on the [Battery Compatibility manual](#) to see if enabling DVCC has been tested with your battery type and is supported. **If DVCC is not mentioned in notes relating to your battery, do not enable DVCC.**
- For Gel, AGM, OPzS and other lead-acid batteries, DVCC can be used without any problem. The same is true for Victron Energy Lithium Battery Smart with the VE.Bus BMS, the Lynx Ion + Shunt BMS or the Lynx Ion BMS. DVCC is forced-enabled for the Lynx Smart BMS.

### 2. Firmware versions

Do not use DVCC in cases where these requirements are not met. In all cases, we recommend installing the latest available firmware during commissioning. Once running well, there is no need to update firmware proactively without reason. In case of difficulty, the first action is to update firmware.

Required minimum firmware versions:

Victron product	Minimum firmware version
Multi/Quattro	422
MultiGrid	424
Multi RS, Inverter RS, MPPT RS	v1.08
GX device	v2.12
VE.Direct MPPTs	v1.46
VE.Can MPPTs with VE.Direct	v1.04
Older style VE.Can MPPT Solar Chargers (with the screen)	Cannot be used
Lynx Ion + Shunt	v2.04
Lynx Ion BMS	v1.09
Lynx Smart BMS	v1.02
Orion XS	v1.00

From Venus firmware v2.40, there will be a warning message 'Error #48 - DVCC with incompatible firmware' when one of the devices has an incompatible firmware while using DVCC. For more information about Error #48, see the [Error codes chapter \[123\]](#).

In case of an ESS System, the ESS Assistant needs to be version 164 or later (released in November 2017).

## 11.3. DVCC effects on the charge algorithm

In standalone mode, our inverterchargers, MPPT solar chargers and Orion XS use their own internal charging algorithm. This means they determine how long to remain in Absorption, when to switch to Float, and when to switch back to Bulk or Storage. In those various phases, they use the configured parameters in VictronConnect and VEConfigure.

In ESS systems and systems with managed batteries (see the [Battery Compatibility manual](#)), the internal charge algorithm is deactivated, and the charger then works with an externally controlled charge voltage setpoint. This table explains the different possibilities:

Selection guide			Resulting charge algorithm		
System type	Battery type	DVCC	Inverter/charger	Solar charger	Orion XS
ESS Assistant <sup>1)</sup>	Intelligent battery	On	Battery		
		Off	Don't do this; better enable DVCC		
	Normal battery	On	Internal	Inverter/charger	
		Off	Internal	Inverter/charger	
Standard	Intelligent battery	On	Battery		
		Off	Don't do this; better enable DVCC		
	Normal battery	On	Internal		
		Off	Internal		

<sup>1)</sup> The ESS Assistant is only installed in a specific type of power system that integrates a grid connection with a Victron inverter/charger, GX device and battery system, not to be confused with an off-grid system such as is used in boats or RVs.

### Details

#### • Internal

- The internal charge algorithm (bulk → absorption → float → re-bulk), and the configured charge voltages are active.
- Inverter/charger indicates charge state: bulk, absorption, float, and-so-forth.
- The MPPT indicated charge state is: bulk, absorption, float and-so-forth.
- The Orion XS DC-DC battery charger indicated charge state is: bulk, absorption, float and-so-forth.

#### • Inverter/charger (applies to MPPTs and Orion XS only)

- The MPPTs and Orion XS internal charge algorithm is disabled; instead it's being controlled by a charge voltage setpoint coming from the inverter/charger.
- The MPPTs and Orion XS indicated charge state is: Ext. control.

#### • Battery

- The internal charge algorithm is disabled and instead, the device is being controlled by the battery.
- The Inverter/charger indicated charge state is: Ext. control.
- The MPPT and Orion XS indicated charge state is: Ext. control (the LEDs continue to show bulk and absorption, never float).

### 11.3.1. DVCC effects when there is more than one Multi/Quattro connected

Only the Multi/Quattro (which can be a single device, or multiple together configured for three-/split-phase as well as parallel) connected to the VE.Bus port will be controlled via DVCC. Additional systems, connected to the GX device using an MK3-USB, are not controlled by DVCC and will charge and discharge according to the configuration made in those units.

This applies to all types of systems with DVCC enabled. For example a system that does not include a managed (CAN-Bus) battery, and uses only the DVCC charge current limit: that charge current limit is only applied to the Multi or Quattro connected to the VE.Bus port.

## 11.4. DVCC features for all systems

These features apply to all types of systems when DVCC is enabled; with or without ESS Assistant, with lead-acid or other normal batteries as well as when an intelligent CAN-bus BMS connected battery is installed:

### 11.4.1. Limit charge current



Limit charge current is a user-configurable maximum charge current setting. It works across the whole system, whereby Solar is prioritised first, then the Orion XS DC-DC battery charger and then the inverter/charger.

This setting is available in the Settings → DVCC menu on the GX device.

#### Particulars:

1. If a CAN-bus BMS is connected and the BMS requests a maximum charge current that is different from the user-configurable setting, the lower of the two will be used.
2. This mechanism only works for Victron inverter/chargers including Inverter RS, Multi RS, Solar chargers incl. MPPT RS and Orion XS DC-DC battery chargers. Other chargers, such as Skylla-i's are not controlled and also their charge current is not taken into account. The same applies for devices that are not connected to the GX device, such as an alternator. Worded differently: the total charge current of the inverter/chargers and all MPPT solar chargers will be controlled, nothing else. Any other sources will be extra charge current, unaccounted for. Even when installing a BMV or other battery monitor.
3. DC Loads may not be accounted for, unless a SmartShunt or BMV-712 is installed and correctly configured as a [DC meter](#). For example, without the DC load monitor a configured maximum charge current of 50A and DC Loads drawing 20A, the battery will be charged with 30A, not with the full allowed 50A. With the SmartShunt configured as a DC meter, maximum charge current configured at 50A and DC system shunt reports a draw of 25A, then the chargers are set to charge with  $50 + 25 = 75A$ .

If you have one or more shunts configured for "DC system" (when more than one, they are added together), then the DVCC charge current limit compensates for both loads and chargers. It will add extra charge current if there is a load, and subtract it if there is another charger in the DC system. DC "loads" and "sources" are not compensated for in either direction.

4. Current drawn from the system by the inverter/charger is compensated for. For example, if 10A is drawn to power AC loads and the limit is set to 50A, the system will allow the MPPT solar chargers to charge with a maximum of 60A.
5. In all situations, the maximum charge limit configured in a device itself, i. e. the Charge current limit set with VictronConnect or VEConfigure for Orion XS DC-DC battery chargers, MPPT solar chargers or inverter/chargers will still be in effect. An example to illustrate this: in case there is only an inverter/charger in the system and in VEConfigure or VictronConnect the charge current is configured to 50A. And on the GX device, a limit of 100A is configured, then the working limit will be 50A.
6. DVCC charge current limits are not applied to DC MPPTs when ESS is enabled with Allow DC MPPT to export. This is to get maximum output from the solar panels for export.

### 11.4.2. Limit managed battery charge voltage

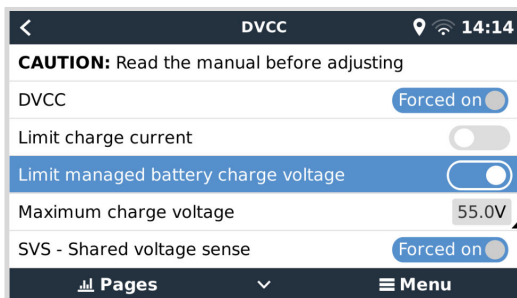

Some batteries (like BYD and Pylontech) that come from the factory will take some time to settle in, and you may need to run them at a **lower voltage** for the first two weeks or so to help them balance.



This is what Limit managed battery charge voltage is designed for. Enabling this makes it possible to lower the maximum charge voltage until cells have balanced.

Do not use it for any other purpose as it may have unwanted side effects, for example, balancing can fail or not start at all if the charge voltage is set too low, causing the battery cells to become severely imbalanced over time. It is also not possible to set the value above the charge voltage limit (CVL) sent by the battery.

### 11.4.3. Shared Voltage Sense (SVS)

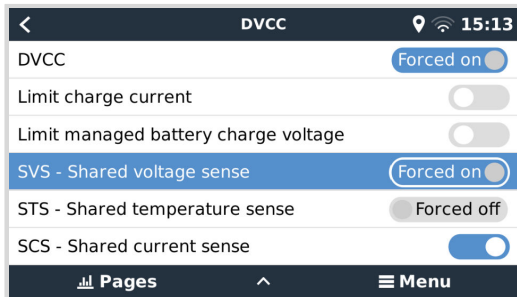

Works with VE.Bus devices, VE.Direct and VE.Can MPPT solar chargers, Orion XS DC-DC battery chargers as well as Inverter RS and Multi RS.

The system automatically selects the best available voltage measurement. It will use the voltage from the BMS or a BMV battery monitor, if possible, otherwise it will use the battery voltage reported by the VE.Bus system.

The voltage displayed on the GUI reflects the same voltage measurement.

Shared Voltage Sense (SVS) is by default enabled when DVCC is enabled. It can be disabled with a switch in Settings → DVCC.

SVS (and DVCC) is force enabled for the Lynx Smart BMS and cannot be changed.

Note that SVS is force-disabled for some batteries. Please see the [compatibility page](#) for your battery.

### 11.4.4. Shared Temperature Sense (STS)

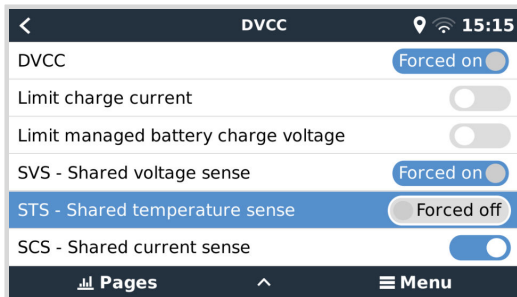

Select the temperature sensor to use; and the GX device will send the measured battery temperature to the inverter/charger system as well as all connected solar chargers and Orion XS DC-DC battery chargers.

Selectable sources for the battery temperature are:

- BMV-702 battery monitor
- BMV-712 battery monitor
- SmartShunt
- Lynx Shunt VE.Can battery monitors
- Multi/Quattro inverter/charger
- Solar chargers (if fitted with a temperature sensor)

Note that STS is forced disabled for the Lynx Smart BMS and some batteries. Please see the [compatibility page](#) for your battery.

### 11.4.5. Shared Current Sense (SCS)

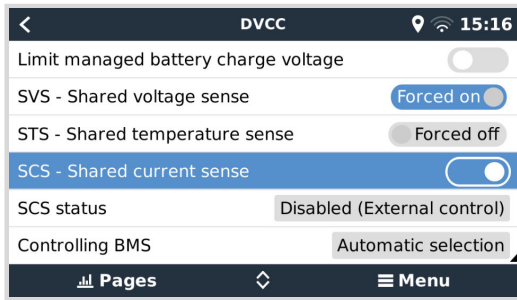

This feature forwards the battery current, as measured by a battery monitor connected to the GX device, to all connected solar chargers and Orion XS DC-DC battery chargers.

Both can be configured to use the battery current for its tail current mechanism that ends absorption when the current is below the configured threshold. For more information about that, refer to solar charger or Orion XS documentation.

This feature only applies to systems that are not ESS and/or don't have a managed battery, since in both of those cases the MPPT and Orion XS is already externally controlled.

Requires MPPT solar charger firmware v1.47 or newer.

### 11.4.6. Controlling BMS

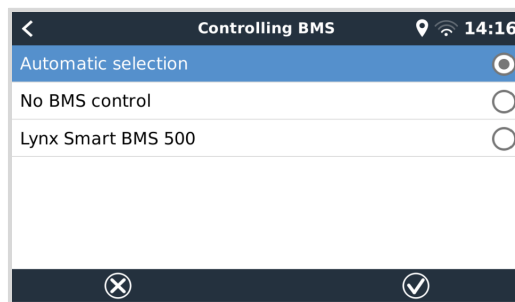
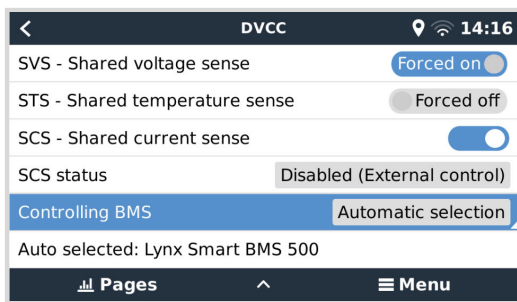

For systems with multiple BMSs connected, this allows selection of which BMS to use for DVCC. This also allows the use of a BMV or SmartShunt for SoC tracking by selecting a BMV as battery monitor (Settings → System setup) while the BMS is still used for DVCC.

This setting is available in the Settings → DVCC menu on the GX device.

## 11.5. DVCC features when using CAN-bus BMS battery

Parameters	
Charge Voltage Limit (CVL)	14.20V
Charge Current Limit (CCL)	330.0A
Discharge Current Limit (DCL)	600.0A

This chapter applies to all systems where an intelligent battery BMS is installed and connected via CAN-bus. Note that this does not include the Victron VE.Bus BMS.

Such intelligent BMS sends the following parameters to the GX device:

1. **Charge voltage limit (CVL):** the maximum charge voltage that the battery currently accepts.
2. **Charge current limit (CCL):** the maximum charge current requested by the battery.
3. **Discharge current limit (DCL):** the maximum discharge current as requested by the battery.

For all three parameters, some types of batteries transmit dynamic values. For example they determine the maximum charge voltage based on cell voltages, state of charge, or for example temperature. Other makes and brands use a fixed value.

For such batteries there is no need to wire allow to charge (ATC) and allow to discharge (ATD) connections to the AUX inputs of a Multi or Quattro.

When inverting, i. e. in island mode, Multis and Quattros will shut down when the max discharge current is zero. They will automatically start again as soon as either AC mains returns or when the BMS increases the max discharge current again.

See previous section [Limit charge current](#), the user-configurable maximum charge current setting, for details about how the Maximum charge current is used, how it prioritises solar and more.

All above means that setting up charge voltages or charge profiles in VEConfigure or VictronConnect is not necessary and will also have no effect. The Multis, Quattros, Multi and Inverter RS, MPPT Solar Chargers and Orion XS DC-DC battery chargers will charge with the voltage as received via CAN-bus from the battery. This also applies to systems with a Lynx Smart BMS connected to a GX device.

## 11.6. DVCC for systems with the ESS Assistant

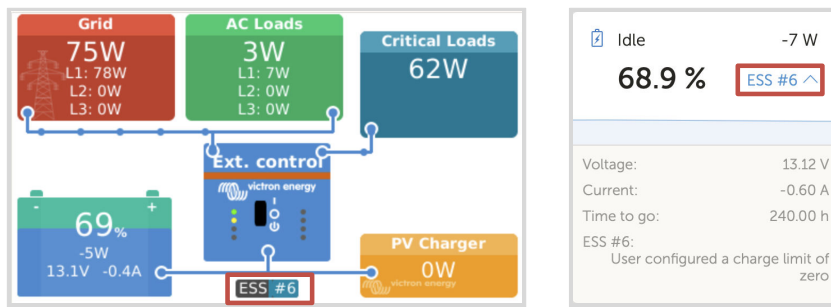

- The ESS Keep batteries charged mode will only work properly with DVCC enabled.
- A fixed solar offset of 0.4V (value for 48V system, divide by 4 for 12V) is applied when ESS-mode is set to Optimised in combination with the Feed-in excess solar charger power-setting enabled, or when ESS-mode is set to Keep batteries charged.
- For system with ESS mode Optimised and Optimised (with BatteryLife): The system will automatically recharge the battery (from the grid) when the SoC drops 5% or more below the value of 'Minimum SoC' in the ESS menu. Recharge stops when it reaches the Minimum SoC.
- ESS status display in the graphic overview of the GX device and on VRM: In addition to the charge status (External Control or Bulk/Absorption/Float), the following status can be displayed:

ESS status	Meaning
#1	Low SoC: discharge disabled
#2	BatteryLife is active
#3	Charging disabled by BMS
#4	Discharging disabled by BMS
#5	Slow charge in progress (part of BatteryLife, see above)
#6	User configured a charge limit of zero
#7	User configured a discharge limit of zero

- Note: When DC-coupled PV feed-in excess is enabled with ESS, the DVCC system will not apply the DVCC charge current limit from PV to battery. This behaviour is necessary to allow the export. Charge voltage limits will still apply. Charge current limits set at the individual solar charger device settings level will also still apply.
- When the BMS is disconnected in an ESS system, solar chargers will stop and show error #67 – No BMS (see the [MPPT Solar Charger Error Codes](#) for additional info).

## 12. VRM Portal

### 12.1. VRM Portal introduction



When connected to the internet, a GX device can be used in combination with the [Victron Remote Management \(VRM\) portal](#), which enables:

- Easy remote access to all statistics and systems status online
- [Remote Console on VRM \[80\]](#): access and configure your system as if you were standing besides it
- [Remote Firmware update](#): Update the firmware of connected Solar Chargers and other Victron products
- [Remote VEConfigure](#): Download and upload Remote VEConfigure files from and to the Multi/Quattro connected to your GX device
- [Remote Controls](#): Control devices such as the EV Charging Station, Inverter/charger, GX relay, Genset and ESS system remotely via VRM
- Use of the [VRM App for iOS and Android](#) including [VRM APP Widgets](#) on your mobile device's homescreen

See the [Internet Connectivity chapter \[37\]](#) for how to connect the device to the internet.

For a complete overview of all features and functions of the VRM Portal, see the [VRM Portal documentation](#).

### 12.2. Registering on VRM

Detailed instructions are in the [VRM Portal Getting Started document](#).

Note that any system will need to first have been able to successfully send data to the VRM Portal. As long as there has been no successful connection, it will not be possible to register the system to your VRM user account. In such case, refer to below [Troubleshooting data logging \[77\]](#) and [Remote Console on VRM - Troubleshooting \[81\]](#) section.

### 12.3. Datalogging to VRM



Datalogs are transmitted to the VRM Portal over the Internet, if available. All related settings are available in the VRM Online Portal menu (Device List → Settings → VRM online portal).

The transmission of the datalogs has been designed to work also on bad internet connections. Connections with up to 70% permanent packet loss are still enough to get the data out, albeit partially delayed.

#### Adding an external storage device

When unable to transmit the logs, then the GX device will store them to non-volatile storage (ie. data is not lost on a power loss or reboot).

The GX device has a buffer to store a couple of days worth of logs internally. To extend this period, insert a microSD card or USB stick. You can see the internal storage status in the settings.

Note that, when inserting such storage device, any internally stored logs will automatically be transferred to the inserted stick: no data is lost.

With or without an external storage device inserted, the GX device will always keep trying to connect to the portal and transmit all backlogged logs. That means that even with months worth of backlog, once it re-acquires an Internet connection, all of the backlog is sent out. The data is sent in a compressed manner: sending a lot of backlogged data will use considerably less bandwidth than sending the data with a continuously available internet connection.

### Storage device requirements

- Supported file systems for MicroSD cards or USB flash drives are FAT (12, 16, 32), ext3, ext4 and exFAT.
- SD and SDHC type microSD cards of 32 GB capacity and smaller are sold containing FAT12, FAT16 or FAT32. They can be used without a problem, unless they are subsequently re-formatted to an unsupported file system.

### Manually transferring datalogs to VRM

For devices permanently without Internet, it is possible to take the data out, and then upload it manually from a laptop.

1. Go to Settings → VRM online portal, and click Eject the storage. Make sure to never just remove the SD-card/USB-stick, this can lead to corruption and data loss.
2. Remove the storage device and insert it into a computer or laptop that is connected to the internet.
3. Open a webbrowser, and navigate to the [VRM Portal](#).
4. Login and then navigate to the Installations menu:

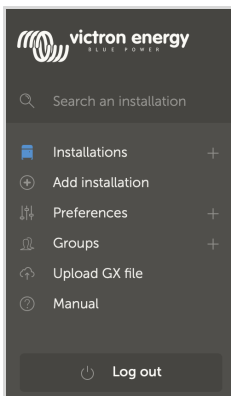

5. Click the 'Upload GX file' option and follow instructions:

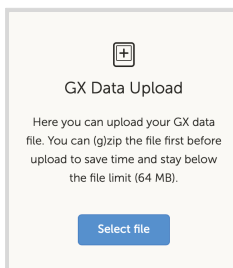

6. Remove the file from the storage device and re-insert it into the GX device. Note that uploading the same data twice does not cause any problems; but still it is better not to do that.

With a log interval of once per minute, the required storage space roughly amounts to about 25 MB per month, depending on the number of connected products. So with a 1 GB microSD card, you can store about 3 years of backlog. In other words, any microSD card or USB stick should be sufficient to store the 6 months of data which VRM retains. When the storage device is full, no more data will be logged.

If multiple storage devices are inserted, the GX device will store the data on the one inserted first. When that is removed, it will not use the other one. Instead, it will create an internal backlog buffer. Only inserting a new one will make it switch to using external storage again.

### Network watchdog: auto-reboot

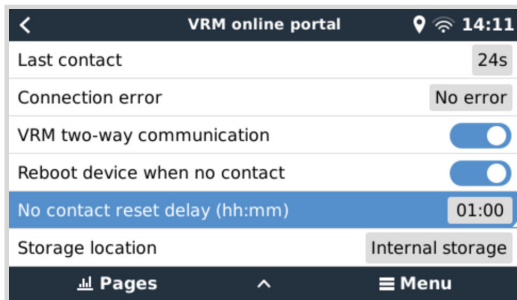

This feature, disabled by default, makes the GX device automatically reboot itself in case it has not been able to connect to the VRM Portal.

## 12.4. Troubleshooting data logging

This chapter guides you through the troubleshooting that needs to be done when the GX device cannot transmit data to the VRM portal.

### Initial check

First, check whether there is a connection between the GX device and the VRM portal and whether data is being sent or not.



Don't worry if the GX device has lost connection to the Internet for a short time. The data logs that were not transmitted during this time are temporarily stored in the GX device and will be transmitted once the Internet connection is restored.

1. Check the 'Last contact' entry in the menu of the VRM online portal (Settings → VRM online portal → Last contact).
  - If the displayed time is within the defined 'Log interval' setting in the same menu, this indicates that data is actively being sent to VRM, which means everything is working properly.
  - If it shows dashes, the GX device has been unable to contact the VRM Portal since it was powered up.
  - If it shows a time, but an error is shown, then the GX device has been able to send data, but has since lost contact.
  - If 'Logging enabled' is deactivated, then the GX device will not send any data to the VRM Portal.

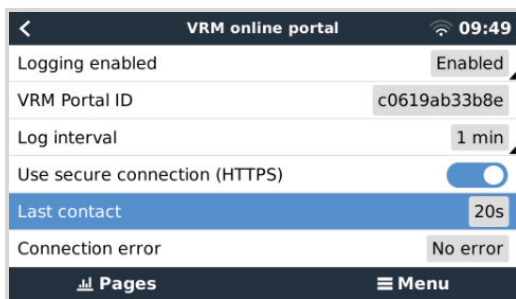

2. Check the 'Stored records' entry in the same menu.
  - The 'Stored records' indicates the number of logs that it has stored to send later.
  - If this number is 0, it means that the Color Control GX has sent all its data to the VRM Portal, which in turn means that the connection is actually working.
  - If this is larger than 0, it means that the Color Control GX can not connect to the VRM Portal.

This is usually accompanied by an error message, which is described later in the chapter.

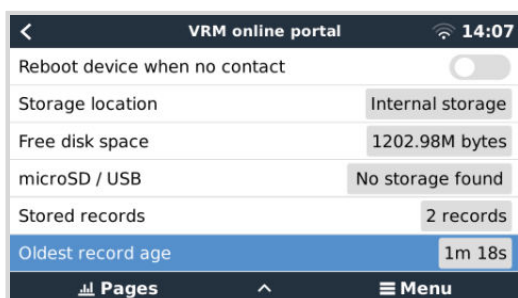

- If you continue to have issues with data logging, please read on.

#### The communication required to send data logs to the VRM Portal is:

1. **A good working internet connection** - Preferably use a wired connection via Ethernet cable. Tethered or hotspot connections, e.g. with a cell phone, are unreliable and often interrupted or they do not automatically restore the connection after it was lost.
2. **A proper IP address** - Normally the router takes care of this and assigns the IP address to connected devices/computers automatically via DHCP as soon as you connect to them. A manual configuration is not necessary.

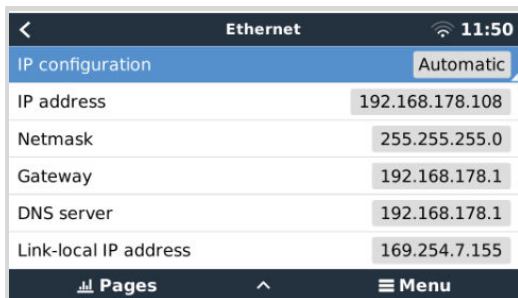

3. **Outbound http(s) connection to <http://ccgxlogging.victronenergy.com> on port 80 and 443** - Note that should never be an issue, unless on very specialised company networks.

Note that the CCGX does not support a proxy setup. For more details on the required networking, see the FAQ [Q15: What type of networking is used by the Color Control GX \(TCP and UDP ports\)?](#) [127].

#### Troubleshooting steps

##### 1. Update the GX device to the latest available firmware

See the [Firmware updates](#) [58] chapter for details

##### 2. Verify the network and internet connection

- Check if the network router has automatically assigned an IP address to the GX device in the Ethernet or Wi-Fi menu (Settings → Ethernet → IP configuration → Automatic or Settings → Wi-Fi → Wi-Fi networks → [Your\_connected\_WiFi\_network] → IP configuration → Automatic). This also applies to manually configured IP addresses. Make sure the following conditions are met:
  - State must be 'Connected'
  - There must be an IP address that does not start with 169.
  - There must be a Netmask
  - There must be a Gateway
  - There must be a DNS server

For a GX GSM or GX LTE 4G, see the [Troubleshooting guide](#) in the GX LTE 4G manual.

If the IP address starts with 169, check whether your network has a DHCP server running. 99% of all networks have a DHCP server running, and it is enabled by default on all well-known ADSL, cable and 3G/4G routers. If there is no DHCP server running, then configure the IP address manually as described in the [Manual IP configuration](#) [39] chapter.

##### • Ethernet

- When using Ethernet and 'State' shows 'Unplugged', verify that the Ethernet network cable is not faulty: try another one. The two lights at the back of the CCGX, where the Ethernet RJ45 cable plugs in, should be lit or blinking. Two dead lights indicate a connection problem.

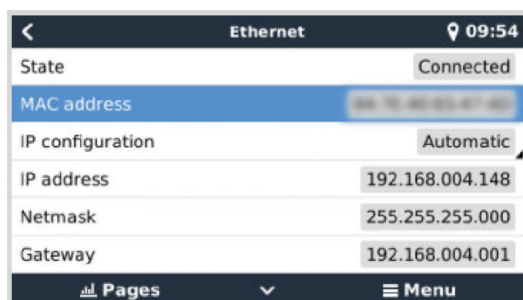



- **WiFi**

- When using WiFi and the menu shows 'No WiFi adapter connected', check the USB connection to the WiFi dongle. Try to remove the dongle and insert it again.
- When using WiFi and the 'State' shows 'Failure', it might be that the WiFi password is incorrect. Press 'Forget network' and try to connect again with the correct password.

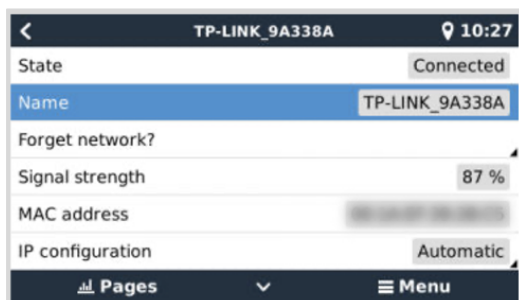

### 3. Check the Connection error status

- Navigate to Settings → VRM online portal and check the 'Connection error' status:

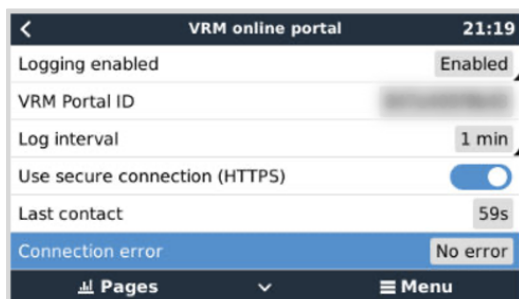

- If a Connection error is shown, the CCGX is not able to contact the VRM database. The connection error will show an error code that indicates the nature of the connectivity problem. Also, details of the error message are shown, to facilitate on-site IT experts to diagnose the problem.
- **Error #150 Unexpected response text:** The http/https call succeeded, but the response was incorrect. This indicates that there is a WiFi or network login page, sometimes called a "captive portal", occasionally seen in Airports, Hotels, Marinas or RV campgrounds. There is no solution to make the GX device work with a WiFi network that requires such a login page and/or accepting of terms of use.
- **Error #151 Unexpected HTTP Response:** A connection succeeded, but the response did not indicate a successful HTTP result code (normally 200). This might indicate that a transparent proxy is hijacking the connection. See #150 above for examples.
- **Error #152 Connection time-out:** this could indicate a poor-quality internet connection or a restrictive firewall.
- **Error #153 Connection error:** this could indicate a routing problem. For details, check the shown error message:



- **Error #153 Connection problem,** and then specifically an SSL related issue, such as in below screenshot: check the date and time setting of the Gx Device, and also the time zone. And check that your router is not showing a special disclaimer, login or acceptance page, like often seen in airports, hotels and other public wifi.

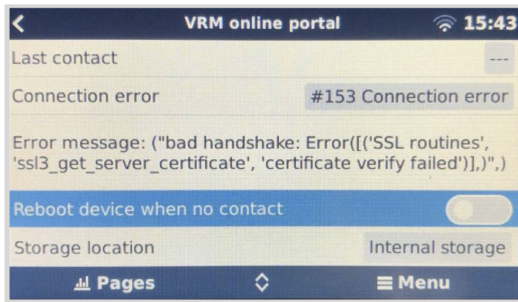

- **Error #154 DNS Failure:** Make sure that a valid DNS server is configured in the Ethernet or WiFi menu. Typically this is assigned automatically by a DHCP server in a network.
- **Error #155 Routing error:** VRM is unreachable. This error occurs if an ICMP error is received, indicating that no route exists to the VRM server. Make sure your DHCP server assigns a working default route, or that the gateway is correctly configured for static configurations.
- **Error #159 Unknown error:** This is a catch-all error for errors that cannot be directly categorised. In such cases the error message will provide information about the problem.

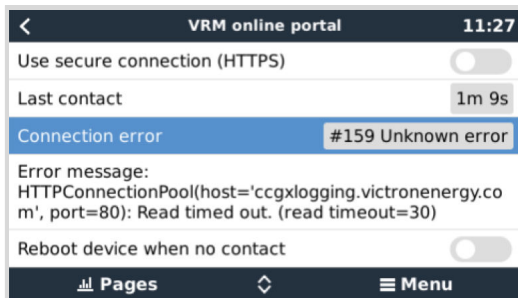

## 12.5. Analysing data offline, without VRM

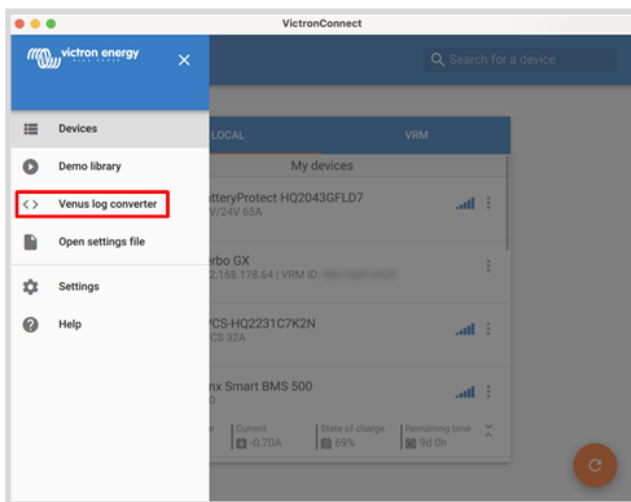

In certain cases, for example for very remote sites where there is no internet available, it can be useful to be able to analyse the data without first having to upload it to the VRM Portal.

1. Install VictronConnect on a Windows or Apple laptop
2. Insert the storage device containing the log file(s)
3. Open VictronConnect and use the Venus Log Converter feature to convert them to Excel sheets. Note that the Venus Log Converter is not available in the iOS and Android version of VictronConnect. See [Importing and converting a GX Product Family database File](#) for more details in the VictronConnect manual.

## 12.6. Remote Console on VRM - Setup

This feature allows full remote control of a GX device over the internet:

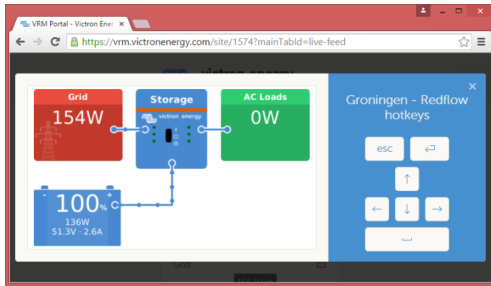

The Remote Console on VRM is disabled by default. Activate it by following these steps:

1. Enable the feature in the Settings → Remote Console menu.  
For details, see the [The Remote Console menu \[44\]](#) chapter.
2. Either set a password or disable the password.
3. Restart the GX device.

Now the Remote Console option will appear in the menu on the VRM Portal. Click it to open the Remote Console:

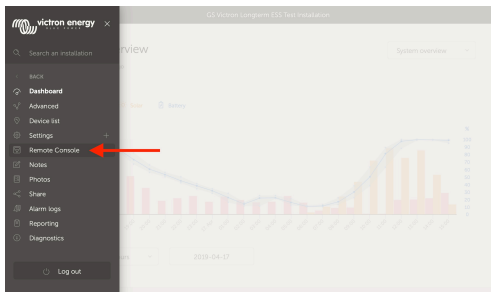

## 12.7. Remote Console on VRM - Troubleshooting

Follow these steps to troubleshoot Remote Console on VRM:

1. Make sure that logging to the VRM portal works, see chapter [Datalogging to VRM \[75\]](#) and [Troubleshooting data logging \[77\]](#). Without this; Remote Console on VRM will not work.
2. After enabling the Remote Console feature, make sure to set (or disable) the password.
3. Also make sure to restart the CCGX after setting (or disabling) the password.
4. Make sure to update the CCGX to the latest firmware version. The last stability improvement for Remote Console was made in version v2.30.
5. After the restart, check the Remote Console on VRM status shows online or a port number. In case it says offline, or port number 0, the CCGX was unable to connect to the Remote Console server. This is normally caused by a (company) firewall, blocking the connection. The solution is then to configure an exception rule in the firewall.
6. Verify that your web browser, on which you're using VRM, can access both of below URLs. Click both of the links to check them. *Note that seeing an Error means that all is OK.* The good error is 'Error response, Error code 405, Method Not Allowed'. If you get a timeout or another (browser) error, there may be a firewall blocking the connection. <https://vncrelay.victronenergy.com> & <https://vncrelay2.victronenergy.com>

### Technical background

To have Remote Console on VRM working, your web browser and the GX device need to have a connection between them. This connection is designed such that it doesn't need any special configuration or opening up of firewalls in almost all situations. The 0.1% of situations where it doesn't work out of the box are, for example, large corporate networks with special security, or long range expensive satellite or radio supported networks, such as seen in rural areas of Africa and other remote areas.

When Remote Console on VRM is enabled, the GX device will open and maintain a connection to any of the servers pointed to by [supporthosts.victronenergy.com](https://supporthosts.victronenergy.com). Which currently resolves to multiple IP addresses (84.22.108.49, 84.22.107.120, 3.25.10.245, 13.244.154.199 or 35.165.124.40, depending on where you are), and likely more in the future. The technology used is SSH, and it will try to connect using port 22, 80 and 443, only one of them needs to work. The reason for it to try all three is that on most networks at least one of them will be allowed by the local firewall.

Once connected to one of the supporthost servers, that reverse SSH tunnel is waiting to be connected from someone needing the connection. Which can be your browser, or a Victron engineer since this same technology is used for the Remote Support functionality; for more information see above.

When using Remote Console on VRM, the browser will connect to either [vncrelay.victronenergy.com](https://vncrelay.victronenergy.com), or [vncrelay2.victronenergy.com](https://vncrelay2.victronenergy.com), using websockets on port 443. For more details of used connections by the GX device, see [Q15 of the FAQ \[127\]](#).

## 13. Marine MFD integration by App

### 13.1. Introduction & requirements

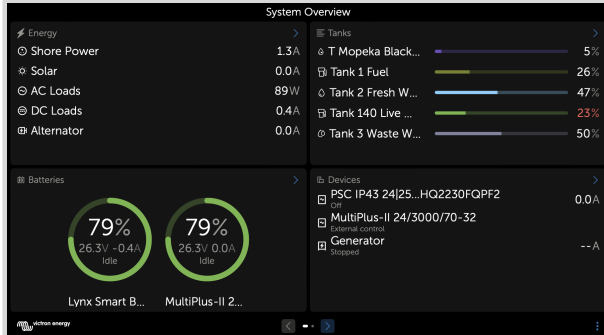

A Glass Bridge is a MFD (Multi-Function Display) that integrates a boat's systems and navigation status into a large screen or screens at the helm of the vessel, so doing away with multiple gauges, brackets and wiring complications.

A Victron system can be easily integrated into a MFD as can be seen in this video:



#### Functionalities:

- Monitor shore power and generator status.
- Monitor battery status for one or more batteries. By using the voltage of for example battery chargers, it can also visualise secondary batteries such as Generator starter batteries.
- Monitor the power conversion equipment: chargers, inverters, inverter/chargers.
- Monitor solar production from an MPPT Solar Charger.
- Monitor AC loads, and DC loads.
- Monitor tank levels and temperatures
- Control shore power input current limit.
- Control the inverter/charger: switch it off, on, or set it to charger-only.
- Optionally open the Victron Remote Console panel; allowing access to further parameters.

Please note that monitoring and control of AC chargers connected via VE.Direct or VE.Can (this applies to Phoenix IP43 Smart Chargers and the Skylla series) only works when shore power is connected.

#### Victron equipment compatibility:

- All Victron inverter/chargers: From a 500VA single-phase device up to a large 180kVA three-phase-system, including Multis, Quattros, 230VAC and 120VAC models.
- Battery Monitors: BMV-700, BMV-702, BMV-712, SmartShunt, and newer, Lynx Shunt VE.Can, Lynx Ion BMS, Lynx Smart BMS
- All Victron MPPT Solar Charge Controllers
- Temperature sensors and tank senders as far as stated in this manual. See the chapters [Connecting Victron products \[8\]](#) and [Connecting supported non-Victron products \[15\]](#) for supported devices.

#### Required components:

- Battery system
- Victron GX device (all models are compatible)
- Victron Inverter/charger
- Victron Battery monitor
- Ethernet network cable connected between MFD and the GX device
- MFD specific ethernet adapter cable (only for some brands, see detailed information in below links)

#### Using the App for other purposes

The app as visible on the MFDs is a HTML5 app hosted on the GX device. It can also be accessed from a regular PC (or mobile device) by navigating a browser to: <http://venus.local/app/>, or replace venus.local with the GX IP address.

## 13.2. Raymarine MFD Integration

### 13.2.1. Introduction

This chapter explains how to connect to Raymarine MFDs using an Ethernet connection. Also, the last chapter explains the Raymarine specifics when connecting on NMEA 2000.

The integration technology used is called [LightHouse Apps](#) by Raymarine.

Note that there is an alternative method to connect, which is NMEA 2000. For details see the [Marine MFD integration by NMEA 2000 \[96\]](#) chapter.

### 13.2.2. Compatibility

The MFD integration is compatible with the Axiom, Axiom Pro and Axiom XL MFDs running on LightHouse 3 and Lighthouse 4. The multifunction displays of the eS and gS series that have been upgraded to LightHouse 3 are not compatible.

Raymarine MFDs need at least LightHouse v3.11 for compatibility, which was released in November 2019.

From Victron side, all GX devices (Cerbo GX, Color Control GX, Venus GX, and so forth) can be used and are compatible. For details on detailed product compatibility with regarding to inverter/chargers and other components, see the main [Marine MFD Integration by App \[83\]](#) chapter.

### 13.2.3. Wiring

The MFD needs to be connected to the GX device using ethernet. It is not possible to connect over WiFi. For the ethernet connection, a RayNet adapter is required.

The RayNet adapters can be purchased from Raymarine:

Raymarine part number	Description
A62360	RayNet (F) to RJ45 (M) - 1m
A80151	RayNet (F) to RJ45 (M) - 3m
A80159	RayNet (F) to RJ45 (M) - 10m
A80247	RayNet (F) to RJ45 (F) Adapter
A80513	RayNet male to RJ45 adaptor cable

To connect the GX device to the internet as well, use WiFi. If the Axiom MFD is connected to internet (using WiFi), it will automatically share its connection with the GX device over ethernet.



Connecting a Axiom MFD to a network router over Ethernet leads to IP address conflicts, due to the integrated DHCP server in the Axiom MFD.



It is not possible to use a GX GSM or GX LTE 4G, due to the integrated DHCP server in the Axiom MFD.



As of Raymarine LightHouse v3.15, there is an option to toggle DHCP. Disabling this option does not mean that the Axiom MFD will work with third party network routers. See [this post on Victron Community](#) for more information.

### 13.2.4. GX device configuration

1. On the Victron GX device, go to Settings → Services, and there enable both MQTT on LAN (SSL) and MQTT on LAN (Plaintext).

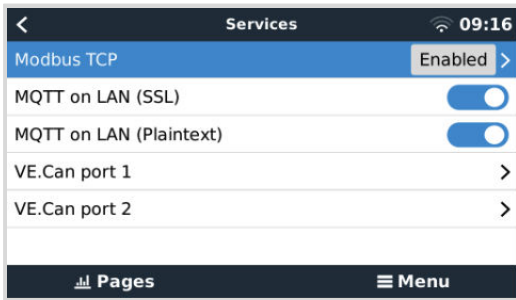

2. Next, go to Menu → Settings → System Setup → Battery Measurements, and there set up what batteries you want to see on the MFD; and by what name.

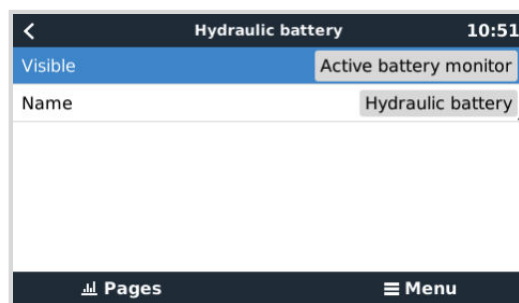
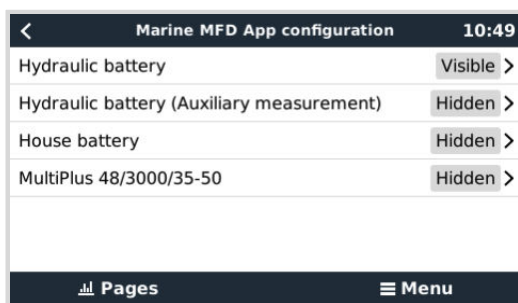

3. For boats, RVs and other applications with DC loads such as lighting and a Battery Monitor installed, make sure to enable the “Has DC system setting”. For more information about it, see the [Menu structure and configurable parameters \[45\]](#) chapter.

No other settings such as IP addresses or similar are required, since the Axiom MFDs have an integrated DHCP server.

### 13.2.5. Configuring multiple battery measurements

This video explains how to set up multiple battery measurements and how to name them.



### 13.2.6. Installation step-by-step

1. Connect the RayNet adapter cable to the MFD
2. Connect the RJ45 end of the RayNet adapter cable to the Ethernet port of the GX device
3. On the MFD go to Apps and then select the Victron logo
4. And...you're done. All information can now be viewed on one screen, which is:  
DC loads, Battery information, Shore power connection, Solar production, AC loads, Inverter and Generator control and the option to open the Remote Console

This video shows the exact steps:





After connecting the Ethernet cable the GX device, it receives an IP number from the Axiom DHCP. If you start the Victron App on the Axiom and it shows "hardware devices not found", just restart the Axiom and see... it works!

### 13.2.7. NMEA 2000

Besides connecting over ethernet, a Raymarine MFD can also be connected to the Victron system using NMEA 2000. If you're new to NMEA 2000 & Victron, start with reading the [Marine MFD integration by NMEA 2000 \[96\]](#) chapter.

The below sections explain the specifics of NMEA 2000 when connecting Victron to a Raymarine MFD.

### 13.2.8. Generic and supported PGNs

To setup the data sources on the Raymarine, go to Settings > Network > Sources > Advanced.

If you have more than 1 battery be sure to adjust the settings of the Axiom to the correct amount of battery(banks).

The following Victron related PGNs are supported by Raymarine:

PGN	Description
127505	Fluid level (tank levels)
127506	DC Detailed Status (State-of-charge, Time-to-go)
127507	Charger status
127508	Battery Status (Battery Voltage, Battery Current)
127509	Inverter status

Note that *J1939 - AC data* is not supported by Raymarine.

When the NMEA 2000/STNG network has GPS data, the GX device sees this as a GPS source and is able to use the GPS position in VRM.

### 13.2.9. Instancing requirements when using Raymarine

Fluid instancing details:

- Raymarine i70: max number of tank levels is 5; fluid instance 0-4 and type must be fuel
- Raymarine i70s: max number of tank levels is 5; fluid instance 0-4 and type must be fuel
- Axiom MFDs: per Lighthouse version 4.1.75, a maximum of 16 tanks can be connected; fluid instance 0-15

### 13.2.10. Before LightHouse 4.1.75

If there is more than one ie. SmartShunt in the NMEA 2000 network, or a solar charger and a SmartShunt, or any other device transmitting the same type of PGNs, then the Data instances of these PGNs must be changed to make each Data instance unique.

Typically this concerns the Battery instance, used in the Battery Status and DC Detailed PGNs.

See here for how to do that: [Changing NMEA 2000 Instances](#), section Data instances. This requires an [Actisense NGT-1 NMEA 2000 to PC \(USB\) Interface](#).





This requirement of Data instances being globally unique for a PGN is specific to Raymarine. Other brands do not require this. And, although perhaps besides the point, also the NMEA 2000 standard does not require it. More specifically, it says: "Data instances shall be unique in the same PGNs transmitted by a device. Data instances shall not be globally unique on the network."

### 13.2.11. LightHouse 4.1.75 and newer

As of LightHouse version 4.1.75, the battery instances no longer need to be unique. This means that you can leave the battery instance to its default value, which is typically set to 0. The batteries are automatically detected by the Axiom display.

## 13.3. Navico MFD Integration

### 13.3.1. Introduction

Navico is the overall brand behind the B&G, Simrad and Lowrance MFDs.

This chapter explains how to connect to Navico MFDs using an Ethernet connection.

Make sure to also study the [Marine MFD Integration by App \[83\]](#) chapter.

Note that there is an alternative method to connect, which is NMEA 2000. For details see the [Marine MFD integration by NMEA 2000 \[96\]](#) chapter.

### 13.3.2. Compatibility

Navico compatible hardware:

Brand	Product	Display Size							Remarks
		7"	9"	10"	12"	16"	19"	24"	
<b>Simrad</b>	NSO EVO3/S					16	19	24	
	NSS EVO3/S	*	9		12	16			NSS7 EVO3 is compatible
	IDS		9		12				
	NSX	7	9		12				Uses a different browser. Not all features are currently supported.
	Go*	7*	9		12				Go5 is not compatible Go7 XSR is compatible while Go7 XSE is not
<b>B&amp;G</b>	Zeus <sup>3</sup> /3S Glass Helm					16	19	24	
	Zeus <sup>3</sup> /3S	*	9		12	16			Zeus <sup>3</sup> 7 is compatible
	Zeus S	7	9		12				Uses a different browser. Not all features are currently supported.
	Vulcan*	7*	9		12				Vulcan 5 is not compatible Vulcan 7R und 7FS are not compatible
<b>Lowrance</b>	HDS Pro		9	10	12	16			
	HDS Live	7	9		12	16			
	HDS Carbon	7	9		12	16			
	Elite FS	7	9						

Note that this feature also works on the Simrad NSS evo2 and B&G Zeus<sup>2</sup>, but only limited. Furthermore, it is not officially supported by Victron or Navico, and there will be no new software versions to fix any problems that may arise. In other words, it is not a supported configuration by Navico.

At the moment, it is not possible to control the Victron MFD App other than via the touch screen. This means that you cannot use:

- Local controls, i.e. WheelKey and arrow keys

- Simrad OP50
- B&G ZC2

### 13.3.3. Wiring

The Navico device needs to be connected to the GX device using Ethernet. Its not possible to connect over WiFi. For the Ethernet connection, a Navico adapter is required as the Navico MFDs feature a round water proof connector on the back. The adapters can be purchased from Navico:

- ETHADAPT-2M 127-56
- CABLE RJ45M-5F ETH ADPTR NONWATERPRF

### 13.3.4. GX device configuration

1. On the Victron GX device, go to Settings → Services, and there enable both MQTT on LAN (SSL) and MQTT on LAN (Plaintext).

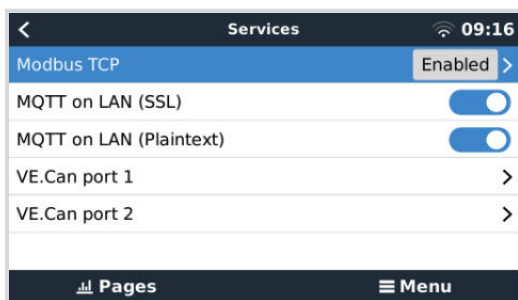

2. Next, go to Menu → Settings → System Setup → Battery Measurements, and there set up what batteries you want to see on the MFD; and by what name.

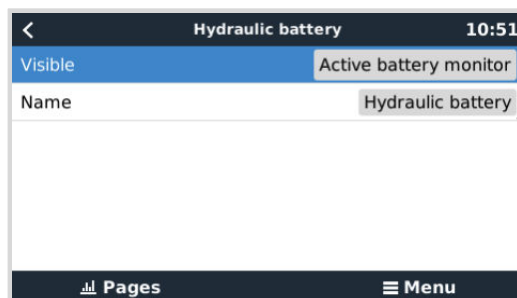

3. For boats, RVs and other applications with DC loads such as lighting and a Battery Monitor installed, make sure to enable the “Has DC system setting”. For more information about it, see the [Menu structure and configurable parameters \[45\]](#) chapter.

No other settings such as IP addresses or similar are required. The GX device and the Navico devices connect to each other using a technology called linklocal addressing.

It is possible to connect the router to the same LAN; and that way connect the GX device to the internet. The GX device can also be connected to the internet via WiFi or with a [GX LTE 4G](#).

Note that the GX LTE 4G can only be used if the MFD and GX device are directly connected to each other, without a router.

### 13.3.5. Configuring multiple battery measurements

This video explains how to set up multiple battery measurements and how to name them.



### 13.3.6. Installation step-by-step

1. Connect the UTP cable to the MFD
2. Connect the other end of the UTP cable to the Ethernet port of the GX device
3. Go to Apps on the MFD and then select the Victron Energy logo, which will appear after a few seconds
4. And...you're done. All information can now be viewed on one screen, which is:  
DC loads, Battery information, Shore power connection, Solar production, AC loads, Inverter and Generator control and the option to open the Remote Console

This video shows the exact steps:



### 13.3.7. NMEA 2000

Besides connecting over ethernet, a Navico MFD can also be connected to the Victron system using NMEA 2000. If you're new to NMEA 2000 & Victron, start with reading the [Marine MFD integration by NMEA 2000 \[96\]](#) chapter.

The MFD can be configured easily to display the data from the GX device. There is no need to change any instance.

To setup the data sources on the MFD, go to Settings > Network > Sources > Advanced.

### 13.3.8. Generic and supported PGNs

To setup the data sources on the Navico MFD, go to Settings > Network > Sources > Advanced.

The following Victron related PGNs are supported:

PGN	Description
127505	Fluid level (tanks)
127506	DC Detailed Status (State-of-charge, Time-to-go)
127507	Charger status
127508	Battery Status (Battery Voltage, Battery Current)
127509	Inverter status

PGN	Description
J1939	AC PGNs

### 13.3.9. Troubleshooting

**Q1:** The MFD page shows outdated information or shows the connection issue page, but the GX device is running and connected and the Victron icon is present on the home page.

**A1:** Try reloading the page by pressing the menu on the top right corner and select HOME.

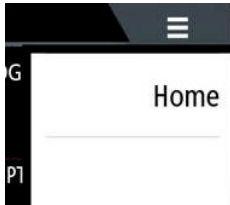

## 13.4. Garmin MFD Integration

### 13.4.1. Introduction

This chapter explains how to connect to Garmin MFDs using an Ethernet connection. The integration technology used is called [Garmin OneHelm](#).

Make sure to also study the [Marine MFD Integration by App \[83\]](#) chapter.

Note that there is an alternative method to connect, which is NMEA 2000. For details see the [Marine MFD integration by NMEA 2000 \[96\]](#) chapter.

### 13.4.2. Compatibility

OneHelm is currently available for the following models:

- GPSMAP® 8400/8600 MFD series
- GPSMAP® 722/922/1222 Plus MFD series

ActiveCaptain is also supported. The screenshot below shows ActiveCaptain with the Victron App.

From Victron side, all GX devices (Cerbo GX, Color Control GX, Venus GX, and so forth) can be used and are compatible. For details on detailed product compatibility regarding inverter/chargers and other components, see the main [Marine MFD Integration by App \[83\]](#) chapter.

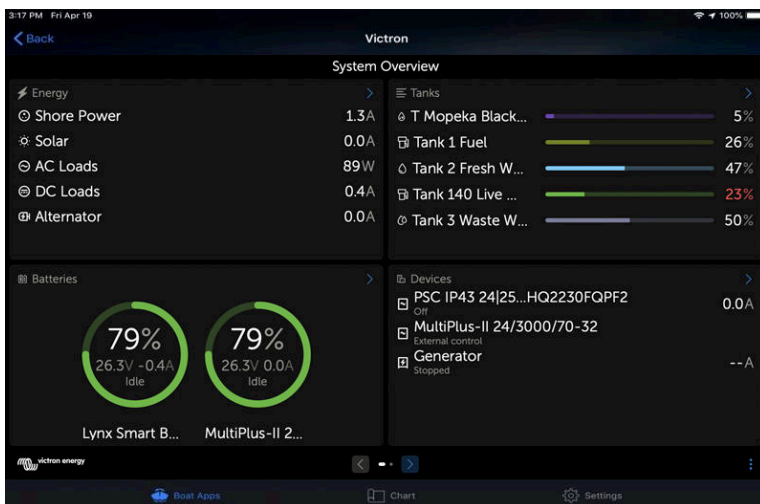

### 13.4.3. Wiring

The Garmin MFD needs to be connected to the [GX device](#) using Ethernet. Its not possible to connect over WiFi. For the Ethernet connection, a Garmin adapter is required:

Garmin part name	Length	Garmin part number
Marine Network Cables	6ft	010-10550-00
Marine Network Cables	20ft	010-10551-00
Marine Network Cables	40ft	010-10552-00
Marine Network Cables	500ft	010-10647-01

### 13.4.4. GX device configuration

1. On the Victron GX device, go to Settings → Services, and there enable both MQTT on LAN (SSL) and MQTT on LAN (Plaintext).

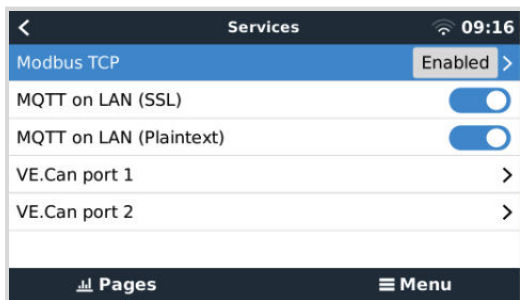

2. Next, go to Menu → Settings → System Setup → Battery Measurements, and there set up what batteries you want to see on the MFD; and by what name.

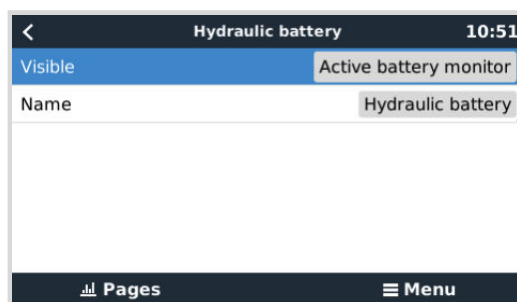
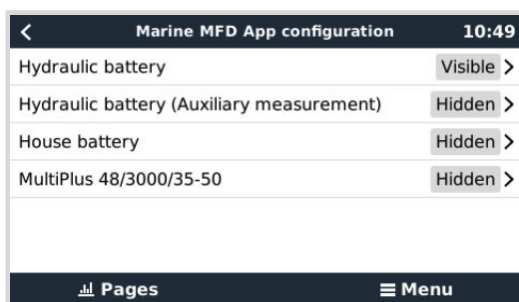

3. For boats, RVs and other applications with DC loads such as lighting and a Battery Monitor installed, make sure to enable the "Has DC system setting". For more information about it, see the [Menu structure and configurable parameters \[45\]](#) chapter.

No special networking settings are necessary. Not on the Garmin; and not on the Victron GX device.

The Garmin MFDs run a DHCP server; and the GX device are by default configured to use DHCP. After plugging in the cable, the Victron Energy icon will show up after 10 to 30 seconds.

To connect the GX device to the internet and the [VRM Portal](#) while its Ethernet port is already in use to connect to the Garmin, use WiFi. For more information about it, see the [Internet connectivity \[37\]](#) chapter.



Connecting a Garmin MFD to a network router over Ethernet leads to IP address conflicts, due to the integrated DHCP server.



It is not possible to use a GX GSM or a GX LTE 4G due to the integrated DHCP server of the Garmin MFD.

### 13.4.5. Configuring multiple battery measurements

This video explains how to set up multiple battery measurements and how to name them.



### 13.4.6. Installation step-by-step

1. Connect the UTP cable to the MFD
2. Connect the other end of the UTP cable to the Ethernet port of the GX device
3. Go to Apps on the MFD and then select the Victron Energy logo, which will appear after a few seconds
4. And...you're done. All information can now be viewed on one screen, which is:  
DC loads, Battery information, Shore power connection, Solar production, AC loads, Inverter and Generator control and the option to open the Remote Console

This video shows the exact steps:



### 13.4.7. NMEA 2000

Besides connecting over ethernet, a Garmin MFD can also be connected to the Victron system using NMEA 2000. If you're new to NMEA 2000 & Victron, start with reading the [Marine MFD integration by NMEA 2000 \[96\]](#) chapter.

The MFD can be configured easily to display the data from the GX device. There is no need to change any instance.

To setup NMEA 2000 on the MFD, go to Settings > Communications > NMEA 2000 Setup > Device List. Here you can view information about the connected products and change their names. Note that the names are stored on the MFD and not on the NMEA 2000 device.

### 13.4.8. Generic and supported PGNs

The following Victron related PGNs are supported:

PGN	Description
127505	Fluid level (tanks)
127506	DC Detailed Status (State-of-charge, Time-to-go)
127508	Battery Status (Battery Voltage, Battery Current)

The supported PGNs may vary per model. Please consult the manual of the MFD for a list of supported PGNs.



## 13.5. Furuno MFD Integration

### 13.5.1. Introduction

This chapter explains how to connect to Furuno MFDs using an Ethernet connection.

Make sure to also study the [Marine MFD Integration by App \[83\]](#) chapter.

Note that there is an alternative method to connect, which is NMEA 2000. For details see the [Marine MFD integration by NMEA 2000 \[96\]](#) chapter. Currently, Furuno MFDs only have support for fluid level PGNs sent out by Victron equipment.

### 13.5.2. Compatibility

The MFD integration is compatible with the following Furuno MFDs:

- NavNet TZtouch3 TZT12F
- NavNet TZtouch3 TZT16F
- NavNet TZtouch3 TZT19F
- Navnet TZtouch2 TZT2BB Black box

Note that NavNet TZtouch3 MFDs need at least software version v1.08. The Navnet TZtouch2 TZT2BB needs at least software version v7.01.

Also note that the Navnet TZtouch2 TZTL models are not supported.

From Victron side, all GX devices (Cerbo GX, Color Control GX, Venus GX, and so forth) can be used and are compatible. For details on detailed product compatibility with regarding to inverter/chargers and other components, see the main [Marine MFD Integration by App \[83\]](#) chapter.

### 13.5.3. Wiring

The Furuno device needs to be connected to the GX device using Ethernet. Its not possible to connect over WiFi. For the Ethernet connection, a standard Ethernet cable can be used. The GX device can either be connected directly to the MFD or through a network router/switch.

### 13.5.4. Configuration

#### Ethernet configuration

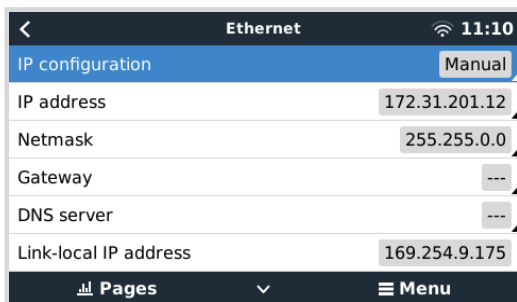

On the Victron GX device, make sure that the Ethernet cable is connected and then go to Settings → Ethernet and set the following configuration:

Setting	Value
IP configuration	Manual
IP address	172.31.201.12
Netmask	255.255.0.0
Gateway	0.0.0.0 or the IP address of the router in your network
DNS Server	0.0.0.0 or the IP address of the router in your network

It is possible to connect a router to the same LAN; and that way connect the GX device to the internet. Make sure the Gateway and DNS Server settings of the GX are set to the IP address of the router, and that the router has its LAN IP addressing configured in the same subnet.



It is not possible to use a GX GSM or a GX LTE 4G.

### GX device configuration

1. On the Victron GX device, go to Settings → Services, and there enable both MQTT on LAN (SSL) and MQTT on LAN (Plaintext).

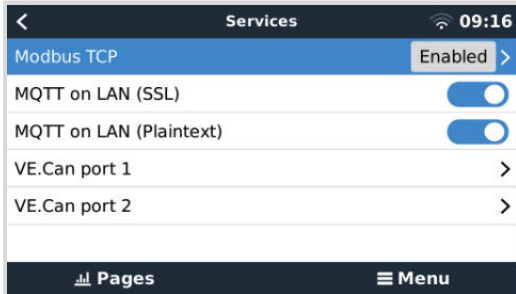

2. Next, go to Menu → Settings → System Setup → Battery Measurements, and there set up what batteries you want to see on the MFD; and by what name.

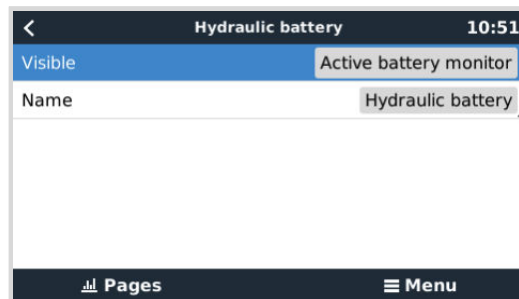
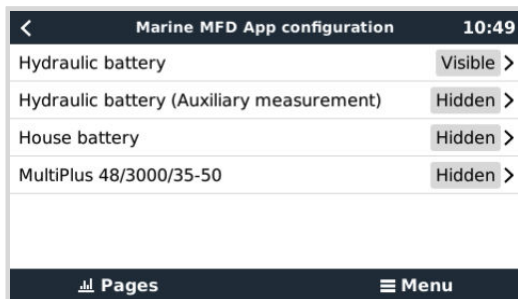

3. For boats, RVs and other applications with DC loads such as lighting and a Battery Monitor installed, make sure to enable the "Has DC system setting". For more information about it, see the [Menu structure and configurable parameters \[45\]](#) chapter.

### 13.5.5. Configuring multiple battery measurements

This video explains how to set up multiple battery measurements and how to name them.



### 13.5.6. NMEA 2000

Besides connecting over ethernet, a Furuno MFD can also be connected to the Victron system using NMEA 2000. If you're new to NMEA 2000 & Victron, start with reading the [Marine MFD integration by NMEA 2000 \[96\]](#) chapter.

This chapter documents the specifics when displaying Victron NMEA 2000 information on Furuno MFDs. Note that this is not meant to be an extensive guide. It's the simple result of our R&D checking everything on a Furuno MFD. The functionality is (mostly) dictated by Furuno software and may therefore also change and improve when Furuno company changes their software.

The MFD can be configured easily to display the data from the GX device. To display tank data, there is no need to change any instance. In order to properly display Battery/DC data from Victron equipment, you need to change the Data instances of the PGNs that are sent out. See here for how to do that: [Changing NMEA 2000 Instances](#), section Data instances.



To view NMEA 2000 devices on the MFD, go to Settings > Initial Setup > Data Acquisition > Sensor List. Here you can view basic information and change Device instances and custom names.

### 13.5.7. Generic and supported PGNs

The following Victron related PGNs are supported:

PGN	Description
127505	Fluid level (tanks)
127506	DC Detailed Status (State-of-charge, Time-to-go) <sup>1)</sup>
127508	Battery Status (limited support); Voltage, Current <sup>(1, 2)</sup>

<sup>1)</sup> The tested Furuno MFD firmware supports a maximum of 4 batteries, no more

<sup>2)</sup> Due to a bug in the MFD firmware, a negative battery current (ie. when discharging) is shown as --- (three dashes)

## 14. Marine MFD integration by NMEA 2000

### 14.1. NMEA 2000 Introduction

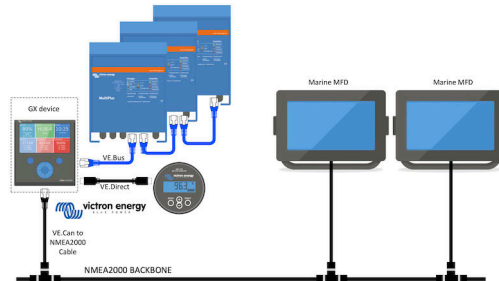

Victron Energy GX devices feature an NMEA 2000-out function: when enabled, the GX device acts as a bridge: it makes all Battery monitors, Inverter/chargers and other products connected to the GX device available on the NMEA 2000 network.

Using that feature, and having the GX device connected a NMEA 2000 network, Marine MFDs can read this data and visualise it to the user. Often in a highly configurable manner.

Use our [VE.Can to NMEA2000 micro-C male cable](#) to connect the GX device to the NMEA 2000 network.

#### **Comparison to the App integration**

Compared to MFD integration using the App, as explained in the previous chapter, integration via N2K offers a more customisable configuration. The downside of integration via N2K is that there is more work in making such configuration, as well as making sure all PGNs and fields therein are supported and compatible between the Victron system and the MFD.

#### **More information**

Besides this chapter, make sure to also read:

1. [The introduction blogpost](#)
2. Our main [Marine NMEA 2000 & MFD integration guide](#)
3. The NMEA 2000 chapter in this manual for the MFD you are using:
  - For Raymarine: [NMEA 2000 \[86\]](#)
  - For Navico: [NMEA 2000 \[89\]](#)
  - For Garmin: [NMEA 2000 \[92\]](#)
  - For Furuno: [NMEA 2000 \[94\]](#)

Yes, that is a lot of reading, but that is basically inherent to NMEA 2000: for example, some of those MFDs support displaying AC data received over the NMEA 2000 wiring, others do not. Some require changing Data instances, others do not, and so forth.

### 14.2. Supported Devices / PGNs

NMEA 2000 defines several messages.

- Messages are identified by their parameter group number (PGN).
- A textual description of the message is publicly available on the NMEA 2000 website (<http://www.nmea.org/>).
- Detailed specification of the protocol and message definition or part thereof can be ordered online on the NMEA 2000 website.
- NMEA 2000 is based on and compatible with SAE J1939. All AC information messages are in the AC status message format as defined in J1939-75. The specification of these messages can be bought on the SAE website (<http://www.sae.org/>).
- For a detailed list of PGNs, please refer to our [Data communication with Victron Energy products whitepaper](#).

#### **Inverter/chargers**

- All inverter/chargers that connect using a VE.Bus port are supported. This includes Multis, Quattros, MultiPlus-IIs, and other (similar) Victron inverter/chargers.

- Data is transmitted out; and its possible to set shore current as well as switch the inverter/charger on and off as well as activate the Inverter only and Charger only modes.

The interface has two functions:

- The function, “153 Inverter”, represents the AC-output
- The function “154 AC Input” monitor represents the AC-input

Charger status messages will be sent by the Inverter function. Both functions have their own network address. Since both functions transmit the same PGNs, for example an AC Status PGN containing voltage, current and more information, NMEA 2000 data consumers like generic displays will need to be able to make a distinction based on the network address. Depending on the function belonging to that network address, the need to interpret it as either Inverter Input or Inverter Output.

- Displays not being capable of doing so will regard the data as belonging to the mains (utility). The Inverter Output is then interpreted as utility #0 and Inverter Input as utility #1. These default instance numbers can be changed by a network configuration tool if necessary.
- Battery temperature, as measured by the inverter(/charger), is transmitted as well.
- All VREG communications need to be sent to the address representing the Inverter function. The other one, AC input, does not support VREG requests: that address only transmits AC information related to the AC input.

### Inverters

- Both, the range of inverters connected via VE.Bus as well as our range of inverters connected using a VE.Direct cable, is supported and its information made available on the NMEA 2000 network.

### Battery monitors

- Supported. This includes any battery monitor as supported by the GX device.
- The battery selected as the system battery in the GX device (Settings → System Setup → Battery Monitor) are transmitted with a fixed Device and Battery instance of 239, this to ensure there is always the same instance for the main (system) battery instead of a system using instance 0 for i.e the Lynx Smart BMS (with built-in battery monitor) and a system with i.e. a SmartShunt using different instances.

### Solar chargers

- Supported. Battery related values as well as the PV Array Voltage & Current is made available on the NMEA 2000 network.

### AC chargers

- Phoenix Smart IP43 Charger 120-240V and 230V models are supported. Only the 120-240V model allows to be remotely controlled (on/off and input current limit) from a compatible MFD.

### Tank level data

- All tank levels visible on the GX device, including GX Tank 140 and Mopeka sensors, are transmitted onto the NMEA 2000 network. The used PGN is 127505 Fluid Level, which includes Fluid instance (aka Data instance), Fluid type (Fuel, Fresh Water, Waste Water, Live Well, Oil, Black Water, Gadoline, Diesel, LPG, LNG, Hydraulic oil and Raw Water) and Fluid level as percentage of tank capacity and tank capacity.

Be careful when using the fluid types LNG, LPG, Diesel and Hydraulic oil: these are relatively new types in the NMEA 2000 standard and not all MFDs and chartplotters support them yet.

- Labelling of the tanks on the MFDs needs to be done on each MFD itself. The custom name as configured in the Victron system is transmitted in the field Installation description #1 in the PGN 126996 - Product Information, but not used by the MFDs.
- The GX device automatically numbers each tank with a unique Device instance and Tank instance. They are made the same. This automatic numbering is done specifically and only for tank levels to make the process of showing them properly on all different brands and types of MFDs as simply as possible.

### Other data and product types

- Not supported. Above explicitly mentioned types are the only ones now supported.

## 14.3. NMEA 2000 Configuration

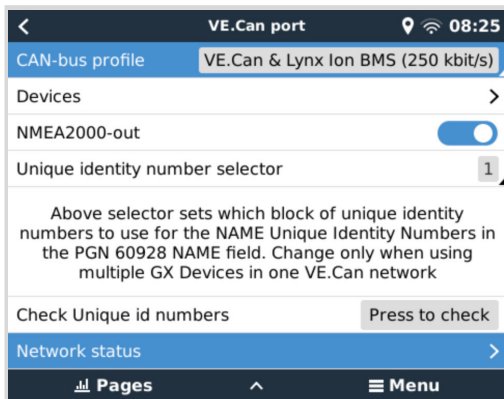

Setting	Default	Description
CAN-bus Profile	VE.Can	Defines the type & baudrate of the CAN-bus network. To use in combination with NMEA 2000, make sure to choose one of the profiles that include VE.Can and is at 250kbit/s
NMEA2000-out	Off	Enables and disables the NMEA2000-out function
Unique identity number selector	1	Selects the block of numbers to use for the NAME Unique Identity Numbers in the PGN 60928 NAME field. For the GX device itself, and when NMEA2000-out is enabled, also for the virtual-devices. Change it only when installing multiple GX devices in the same VE.Can network. There are no other reasons to change this number. For more details regarding the Unique Identity Number, read the last section in this chapter.
Check unique id numbers		Searches for other devices that use the same unique number. When the search is completed, it will respond with either an OK, or the text : <i>There is another device connected with this unique number, please select another one.</i>  Note that there is normally no reason to use this function: the GX device automatically and continuously checks uniqueness of the numbers in use and will warn in case there is a conflict. This setting is made available to quickly confirm that everything is OK after changing the setting.

## 14.4. Configuring Multiple Tank Level Measurements (Raymarine)

Modern Raymarine Axiom MFDs are capable of displaying up to 16 tank levels and smaller MFDs such as the i70 or i70s can display up to 5 tanks.

The following restrictions apply:

- Currently, the Axiom can only display Fuel (default), Fresh Water, Waste Water aka Grey Water, Live Well, Black Water and Gasoline fluid types. The other fluid types such as LNG, LPG, Hydraulic oil and Diesel are not displayed. This is a Raymarine limitation, which may change with a future firmware update.  
  
However, it is possible to configure a specific tank sender's fluid type in the GX device menu to one of the supported ones, and then rename the tank in the Axiom tank settings (Boat Details > Configure Tanks > Tank Settings) to whatever you like, e.g. LPG, which is then displayed as LPG tank on the dashboard.
- The i70 and i70s will display up to 5 tanks where the fluid type must be Fuel. All other fluid types are not displayed.
- For instancing requirements, see the [Instancing requirements when using Raymarine \[86\]](#) section further below.
- All tank senders as mentioned in the chapter [Connecting Victron products \[8\]](#) and [Connecting supported non-Victron products \[15\]](#) are supported.

### Configuration step-by-step

Before proceeding with the following steps, you must connect the GX device to the NMEA 2000 network to which the MFD is connected. Use our [VE.Can to NMEA 2000 micro-C male cable](#) to connect the GX device to the NMEA 2000 network and ensure NMEA2000-out of the VE.Can port is enabled in the GX device.

The procedure below does not replace the Raymarine manual; Be sure to read the Raymarine documentation that accompanies your Raymarine MFD. Visit the [Raymarine Manuals and Documents](#) website for the latest version

1. Connect the tank sensors to your GX device.
2. Make sure the tank sensors are set to a fluid type supported by your MFD.

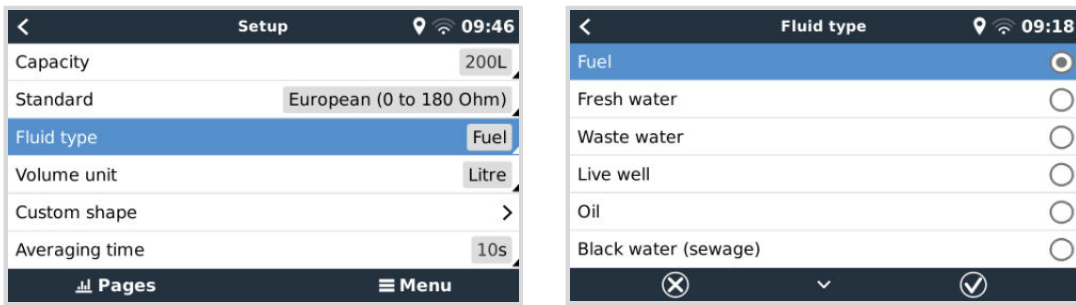

This is done in the setup menu of the tank sensor in the Remote Console - Device List → [your\_tank\_sensor] → Setup → Fluid type

3. On your Axiom MFD, go to Settings > Boat Details > Tanks > Configure Tanks and verify that all tank sensors are listed.

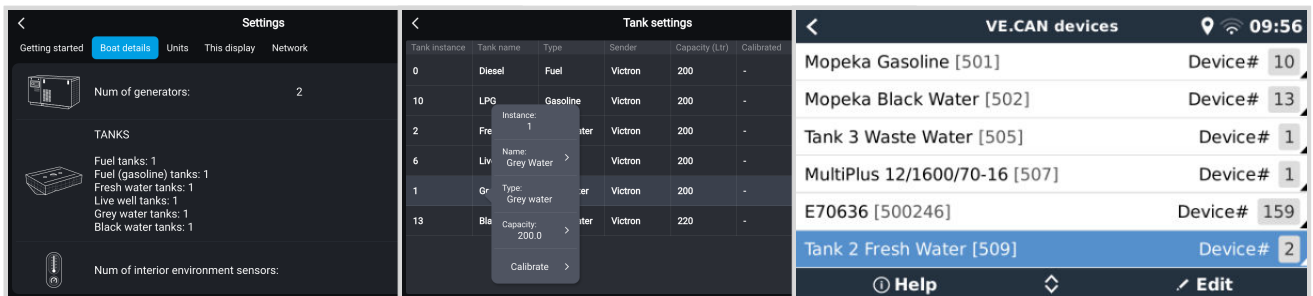

 By briefly tapping on the respective tank, you can change the tank to a meaningful name, which then will be displayed on the dashboard.

4. Open the TANKS dashboard or set up a new page to view the tanks.

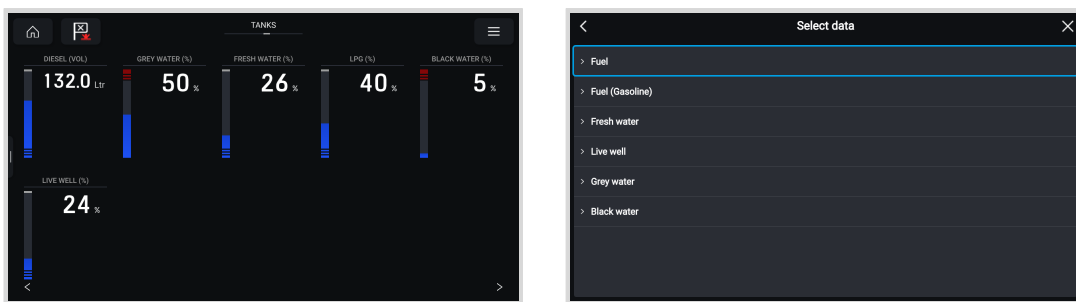

By long tapping on one of the tanks you can make further configurations, e.g. select the tank to be displayed or, if available, change the unit from percent to volume.

## 14.5. Configuring Multiple Tank Level Measurements (Garmin)

Modern Garmin MFDs such as the GPSMAP 84xx series are capable of displaying different types of tank levels.

The following restrictions apply:

1. Currently, the GPSMAP can only display Fuel (default), Fresh Water, Waste Water aka Grey Water, Live Well, Oil, Black Water and Generator fluid types. The other fluid types such as LNG, LPG and Diesel are not displayed. This is a Garmin limitation, which may change with a future firmware updates of your MFD.

However, it is possible to configure a specific tank sender's fluid type in the GX device menu to one of the supported ones, and then rename the tank in the GPSMAP tank settings to whatever you like, e.g. LPG, which is then displayed as LPG tank on the dashboard.

- All tank senders as mentioned in the chapter [Connecting Victron products \[8\]](#) and [Connecting supported non-Victron products \[15\]](#) are supported.

**Configuration step-by-step**

Before proceeding with the following steps, you must connect the GX device to the NMEA 2000 network to which the MFD is connected. Use our [VE.Can to NMEA 2000 micro-C male cable](#) to connect the GX device to the NMEA 2000 network and ensure NMEA2000-out of the VE.Can port is enabled in the GX device.

The procedure below does not replace the Garmin manual; Be sure to read the Garmin documentation that accompanies your MFD; There are some differences in the menu navigation of the various MFDs.

- Connect the tank sensors to your GX device.
- Make sure the tank sensors are set to a fluid type supported by your MFD.

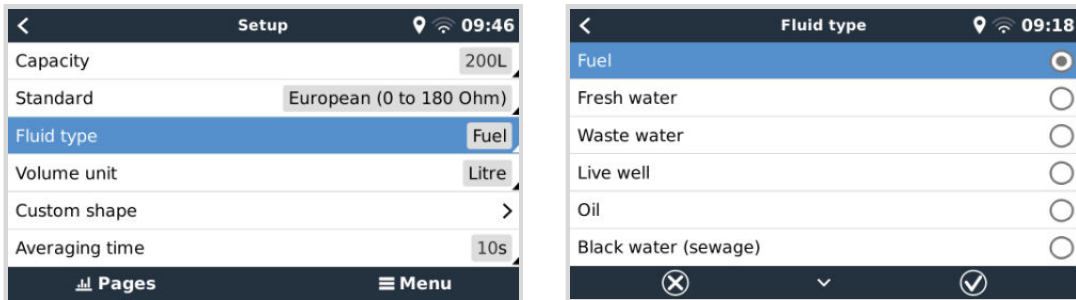

This is done in the setup menu of the tank sensor in the Remote Console - Device List → [your\_tank\_sensor] → Setup → Fluid type

- On your Garmin MFD, go to Settings > Communications > NMEA 2000 Setup > Device List and verify that all tank sensors are listed.

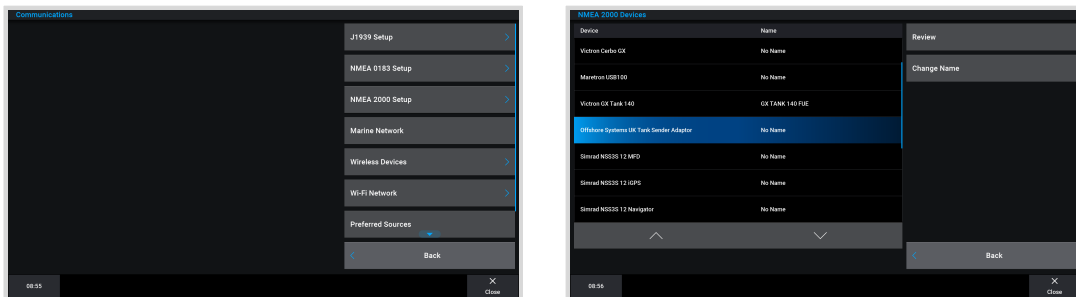

- Configure the tank level sensors by opening a gauges screen and then select Menu > Tank Preset where you can select a tank level sensor to configure, change the name, type, style, capacity and position of the tank.

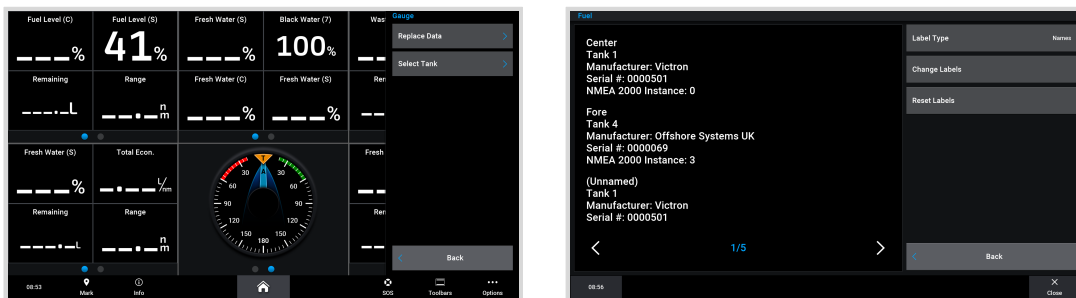

**14.6. Configuring Multiple Tank Level Measurements (Navico)**

Modern Navico MFDs such as the Simrad NSO EVO3 series are capable of displaying different types of tank levels.

The following restrictions apply:

- Currently, a compatible Simrad MFD can only display Fuel (default), Water, Waste Water aka Grey Water, Live Well, Oil and Black Water fluid types. The other fluid types such as LNG, LPG and Diesel are not displayed. This is a Simrad limitation, which may change with a future firmware updates of your MFD.

However, it is possible to configure a specific tank sender's fluid type in the GX device menu to one of the supported ones, and then rename the tank in the MFD tank settings to whatever you like, e.g. LPG, which is then displayed as LPG tank on the dashboard.

2. All tank senders as mentioned in the chapter [Connecting Victron products \[8\]](#) and [Connecting supported non-Victron products \[15\]](#) are supported.

**Configuration step-by-step**

Before proceeding with the following steps, you must connect the GX device to the NMEA 2000 network to which the MFD is connected. Use our [VE.Can to NMEA 2000 micro-C male cable](#) to connect the GX device to the NMEA 2000 network and ensure NMEA2000-out of the VE.Can port is enabled in the GX device.

The procedure below does not replace the Simrad manual; Be sure to read the Simrad documentation that accompanies your MFD; There are some differences in the menu navigation of the various MFDs.

1. Connect the tank sensors to your GX device.
2. Make sure the tank sensors are set to a fluid type supported by your MFD.

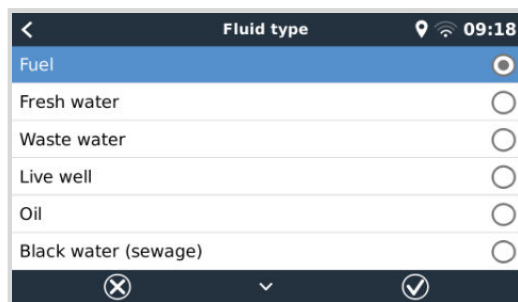
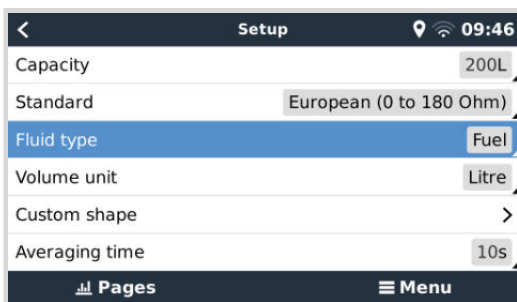

This is done in the setup menu of the tank sensor in the Remote Console - Device List → [your\_tank\_sensor] → Setup → Fluid type

3. On your Simrad MFD, go to Settings > Network > Sources > Advanced > Data source selection and verify that all tank sensors are listed. The tank sensors should automatically be identified by the system. If not, enable the feature from the advanced option in the System settings dialog.

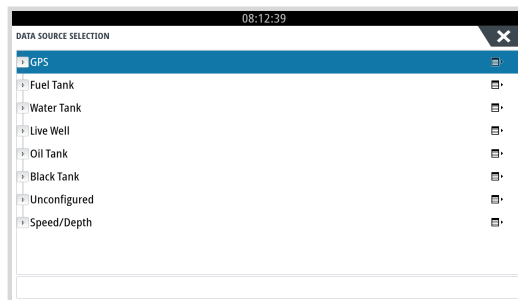
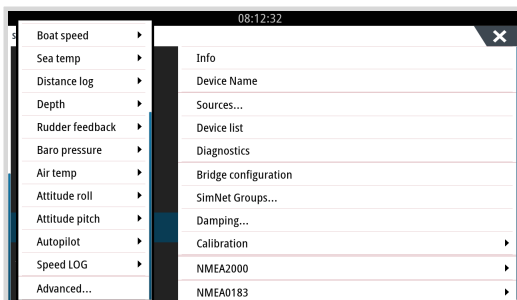

4. Selecting a tank sensor from within the Data source selection menu will bring up additional details and configuration options such as fluid type, location or custom name. Finally, open a dashboard or create a custom dashboard and place the tank sensors as you wish.

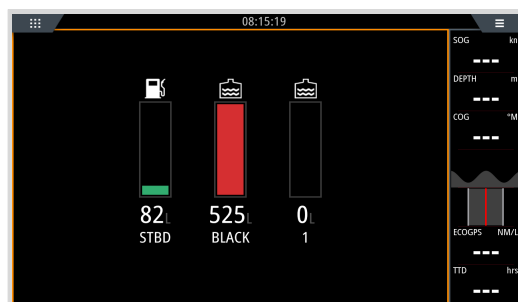
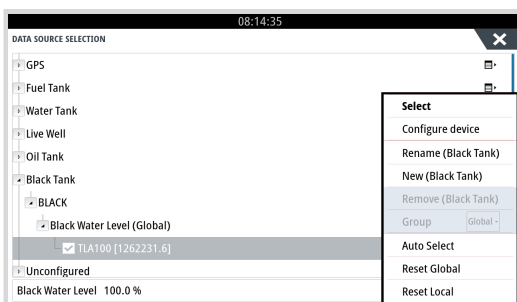

## 14.7. Configuring Multiple Tank Level Measurements (Furuno)

Modern Furuno MFDs such as the NavNet TZtouch3 series are capable of displaying different types of tank levels.

The following restrictions apply:

1. Currently, the NavNet TZtouch3 series can only display Fuel (default), Fresh Water and Black Water with up to 6 tanks for each of the three fluid types.  
However, it is possible to change the "Nickname" for each individual tank in the Engine & Tank Manual Setup menu.
2. All tank senders as mentioned in the chapter [Connecting Victron products \[8\]](#) and [Connecting supported non-Victron products \[15\]](#) are supported.

### Configuration step-by-step

Before proceeding with the following steps, you must connect the GX device to the NMEA 2000 network to which the MFD is connected. Use our [VE.Can to NMEA 2000 micro-C male cable](#) to connect the GX device to the NMEA 2000 network and ensure NMEA2000-out of the VE.Can port is enabled in the GX device.

The procedure below does not replace the Furuno manual; Be sure to read the Furuno documentation that accompanies your MFD; There are some differences in the menu navigation of the various MFDs.

1. Connect the tank sensors to your GX device.
2. Make sure the tank sensors are set to a fluid type supported by your MFD.

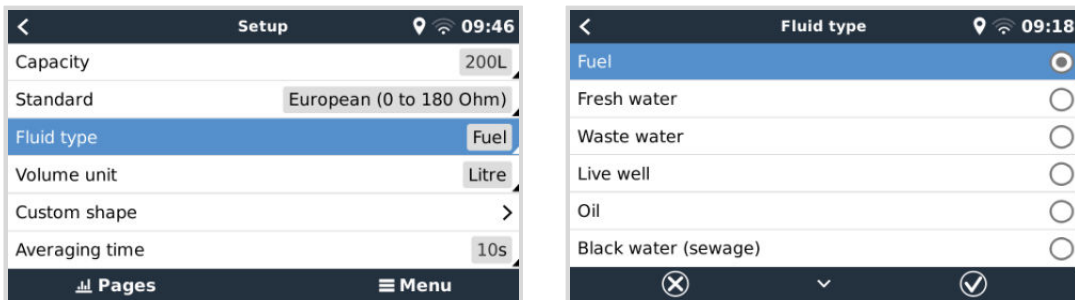

This is done in the setup menu of the tank sensor in the Remote Console - Device List → [your\_tank\_sensor] → Setup → Fluid type

3. The Furuno MFD will automatically detect tanks connected to the same NMEA 2000 network. If this is not possible (check the Engine & Tank Automatic Setup menu), the tanks can be set manually using the Engine & Tank Manual Setup menu.
4. Set up an "Instrument Display" of your choice and add the respective tanks as an "Indication" (as outlined in the Operator's manual) to the instrument display.

## 14.8. NMEA2000-out technical details

### 14.8.1. NMEA 2000 Glossary

Here is a glossary to help with the interpretation of this text:

- **Virtual-device:** a Battery Monitor, Inverter, or other Victron device that does not have a CAN-bus port by itself, made available "virtually" on the CAN-bus by the NMEA2000-out function of the GX device.
- **CAN-bus:** the VE.Can port on the GX device, that, in the context of this chapter, is most likely connected to a NMEA 2000 network.
- **NMEA2000-out:** the software feature in the GX device, which is described in this chapter.
- **NMEA 2000:** Marine CAN-bus protocol, based on J1939.
- **Instance:** there are many types of instances, and explained in detail below.
- **J1939:** A set of standards defining a CAN-bus protocol, defined by the SAE organisation.
- **Address Claim procedure (ACL):** a mechanism, specified by J1939 and used in NMEA 2000 by devices on the network to negotiate and assign each device on the network a unique network addresses. It is a number from 0 to 252. There are three special network addresses defined:
  1. 0xFD (253) - Reserved



2. 0xFE (254) - Unable to claim address - for example when all others are in use
3. 0xFF (255) - The broadcast address

### 14.8.2. NMEA 2000 Virtual-devices

When the NMEA2000-out feature is enabled, the GX device acts as a bridge: it will make each Battery monitor, Inverter/charger or other device that is connected available individually on the CAN-bus. Individually, as in each with its own network address, its own Device instance, function codes, and so forth.

For example, a GX device with two BMVs connected on a VE.Direct port and an inverter/charger connected using VE.Bus, will make the following data available on the CAN-bus:

Address	Class	Function	Description
0xE1	130 (Display)	120 (Display)	The GX device itself
0x03	35 (Electrical generation)	170 (Battery)	The 1st BMV
0xE4	35 (Electrical generation)	170 (Battery)	The 2nd BMV
0xD3	35 (Electrical generation)	153	The inverter/charger (AC-output)
0xD6	35 (Electrical generation)	154	The inverter/charger (AC-input)

### 14.8.3. NMEA 2000 Classes and Functions

As per NMEA 2000 specification, these define the types of senders and devices connected to the CAN-bus. Classes are the main categories and functions specify it to a further detail.

### 14.8.4. NMEA 2000 Instances

Instances are used in an NMEA 2000 network to identify multiple similar products connected to the same network.

As an example, take a system with two battery monitors (one for the main battery bank, and another for the hydraulic-thruster bank) and also a Quattro inverter/charger. All three of those devices will send their battery voltage measurements out on the N2K network. For the displays to show these values at the right place, they need to know which voltage belongs to what battery. That is what instances are for.

There are various types of instances, and for marine systems are two that matter: the Device instance and the Data instance. The Data instance goes by various different names, like Fluid instance, Battery instance and DC instance. NMEA 2000 defines three different instances:

1. **Data instance**
2. **Device instance**
3. **System instance**

For all battery monitors and other devices that the GX device makes available on the CAN-bus, each of the above types of instances is available and can be individually configured.

Per Virtual-device, there is one Device instance and one System instance. And depending on the type of Virtual-device, there are one or multiple Data instances.

For example, for a BMV-712 there are two Data instances, one DC Instance for the main battery and another one for the Starter battery voltage.

How to configure the instances depends on the equipment and software that is used to read them from the CAN-bus. Examples of equipment and software meant here are MFDs such as from Garmin, Raymarine, Furuno or Navico; as well as more software-oriented solutions from for example Actisense and Maretron.

Most of those solutions identify parameters and products by requiring unique Device instances, or using the PGN 60928 NAME Unique Identity Numbers and do not rely on the Data instances to be globally unique.

However, there is one exception:

- Raymarine MFDs may need to change the Data instance to display data properly, depending on the Lighthouse firmware version. For more information, please see the Raymarine-specific [NMEA 2000 \[86\]](#) chapter.

The NMEA 2000 specification specifies the following: "Data instances shall be unique in the same PGNs transmitted by a device. Data instances shall not be globally unique on the network. Field programmability shall be implemented through the use of PGN 126208, Write Fields Group Function."

In other words, Data instances need to be unique only within a single device. There is no requirement for them to be globally unique – the only exception is "Engine Instance" which at least for now, to cope with legacy devices, needs to be globally unique

(e.g. Port = 0, Starboard = 1). For example, some of our BMV battery monitors can measure two voltages, one for the main battery and one for the starter battery, and that's where data instancing is used. Similar for multiple-output battery chargers. Note that there is no need for the installer to change those data instances, as those products are pre-configured to transmit the relevant PGNs with unique Data instances (Battery instance & DC Detailed instance, in this case).



Whilst it is possible to change the Data instances, changing them on a Victron device such as the Skylla-i battery charger will render that device impossible to read correctly by other Victron devices.

This is because the GX device expects the charger's output one to be on Battery & DC instance 0, output two on Battery & DC instance 1, and output three on Battery & DC instance 2. Changing the fluid instance, as well as other data instances for PGNs transmitted by a GX device on an NMEA 2000 network using its NMEA2000-out feature, is no problem.

**A note about the Device instances:** it is not necessary to assign a unique Device instance to each device on the CAN-bus. Its no problem for a battery monitor and a solar charger to both be configured with (their default) Device instance 0. Also when having multiple battery monitors or solar chargers, it is not always necessary to assign each of them a unique Device instance. If at all necessary, they only need to be unique between the devices that use the same Function.

And note that changing the Device instance on a Victron device can change its operation, see the warning above.

### System instances

As per NMEA 2000 specification, this instance is a 4-bit field with a valid range from 0 to 15 that indicates the occurrence of devices in additional network segments, redundant or parallel networks, or sub networks.

The System Instance Field can be utilised to facilitate multiple NMEA 2000 networks on these larger marine platforms. NMEA 2000 devices behind a bridge, router, gateway, or as part of some network segment could all indicate this by use and application of the System Instance Field.

### The ECU instance and Function instance

In some documentation and software tools, yet other terminology is used:

- ECU Instance
- Function Instance
- Device Instance Lower
- Device Instance Upper

Here is how they all relate: the *ECU Instance* and *Function Instance* terminology originates from the SAE J1939 and ISO 11783-5 specification. And they do not exist in the NMEA 2000 definition. However, they all do define the same fields in the same CAN-bus messages which NMEA 2000 defines as *Device instance*.

In more detail: The field that J1939 defines as ECU Instance is in the NMEA 2000 specification renamed to *Device Instance lower*. The Function Instance is renamed to *Device Instance Upper*. And together they form the *Device Instance*, an NMEA 2000 definition.

While using different terms, those fields are the same fields in both standards. Device Instance Lower being 3 bits in length, and Device Instance Upper 5, together 8 bits. Which is the one byte being the NMEA 2000 Device Instance.

### The Unique Instance

The *Unique Instance* is one more word used to describe almost the same information. It's used by Maretron and can be made visible in their software by enabling the column. The Maretron software itself chooses between Device Instance and Data Instance.

## 14.8.5. NMEA 2000 Changing Instances

As the NMEA 2000 protocol prescribes commands to change an instance by sending commands to a device, there are various ways of changing instances. The most commonly used methods are described below. In addition to the methods described here, there are others, for example, some MFDs also allow instances to be modified.

### Commonly used methods to change instances:

1. Remote Console on a GX device: Device instances only
2. Actisense NMEA-Reader software + NGT-1 USB: Device and Data instances
3. Maretron software + USB adapter: Unknown (see Maretron documentation)
4. Commandline of a GX device: Device and Data instances. Note that this required advanced Linux skills; and is listed here only for the benefit of experienced software developers

## Notes on changing Data and Device instances

- **Data instance:**

Even though we recommend not changing Data instances (see the explanation and WARNING above), it is possible to change them.

Venus OS has no option to change them - a third-party tool is required and the only tool we know can do is the Actisense NMEA 2000 Reader.

- **Device instance:**

**WARNING:** these (Victron-)features depend on the Device instance:

1. For an [ESS system](#) with Solar chargers connected to a VE.Can network, those Solar chargers must remain to be configured to their default Device instance (0) for proper operation. This does not apply to VE.Direct-connected Solar chargers made available on the CAN-Bus as a Virtual-device, using the NMEA 2000-out function. Unless the Device instance of the GX device is re-configured to another Device instance. Which is technically possible but not advised and also never required. But in that situation, the chargers must be configured to the same instance as the GX device.
2. For systems with managed batteries, the same.
3. For both, Solar chargers, as well as AC-connected battery chargers, when connected in a VE.Can network, they will synchronise their operation, charge state and such. All chargers must be configured to the same Device instance for that function to work.

In summary, for most systems, we recommend leaving the Device instance to its default, 0.

### Remote Console on a GX device: Changing the Device instance:

The VE.Can devices submenu gives access to a list showing all detected devices on the VE.Can / NMEA 2000 network:

VE.CAN devices		08:36
Cerbo GX [500]	Device#	0
Solar Charger MPPT 150/35 rev2 [501]	Device#	0
MultiPlus 12/1600/70-16 [502]	Device#	0
Solar Charger MPPT 75/15 rev2 [507]	Device#	0
PSC IP43 12 50...HQ2007P5YSI [508]	Device#	0
x Flush Water GX Generic Tank [511]	Device#	0
Help		Edit

- Each entry first shows the name - either the product name as in our database, or when configured, the custom name as configured during installation.
- Then, between the square brackets, the Unique Identity Number is shown.
- On the right you can see the VE.Can Device Instance, which is the same as the NMEA 2000 Device Instance.

Press Enter to edit the specific Device Instance or press the spacebar/right cursor key to go one step deeper in the menu structure to a page showing all the generic data available for that device:

Solar Charger MPPT 75/15 rev2 [507]		08:37
Model Name	SmartSolar Charger MPPT 75/15 re	
Custom Name	Solar Charger MPPT 75/15 rev2	
Careful, for ESS systems, as well as systems with a managed battery, the CAN-bus device instance must remain configured to 0. See GX manual for more information.		
Device Instance	0	
Manufacturer	358	
Network Address	37	
Firmware Version	v1.61	
Serial Number	0000507	
Unique Identity Number	507	
Pages		Menu

### Actisense: Changing Device instances:

Requires the [Actisense NGT-1](#).

To change a Device instance:

1. Open Actisense NMEA Reader
2. Select the network view (tab selection is at the bottom left)
3. Select the product whose Device instance you want to change
4. Select the properties tab at the bottom right and change the Device instance

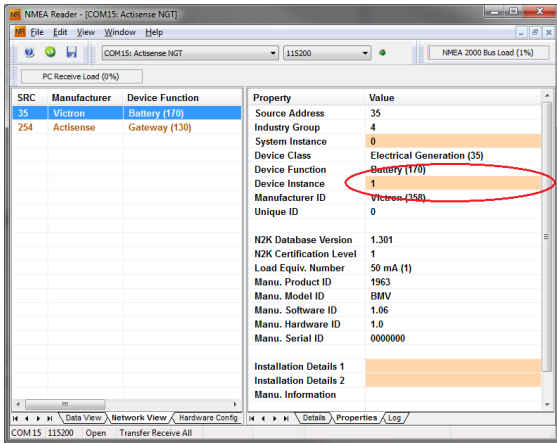

**Actisense: Changing Data instances:**

Requires the [Actisense NGT-1](#).

To change a Data instance:

1. Open Actisense NMEA Reader
2. Select data view (tab selection is at the bottom left)
3. Right click on the PGN number  
Note that this will only work on PGNs that allow changing their Data instance (first screenshot below)
4. And change the value (second screenshot below)

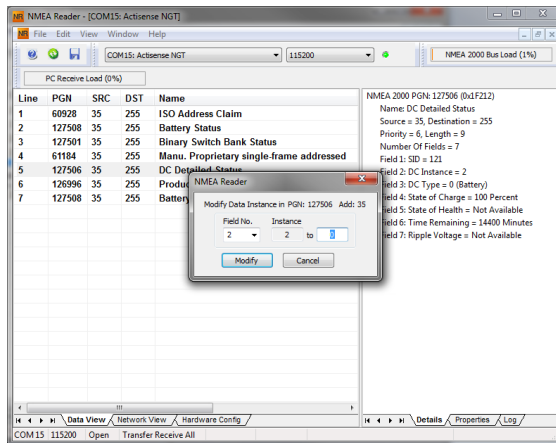
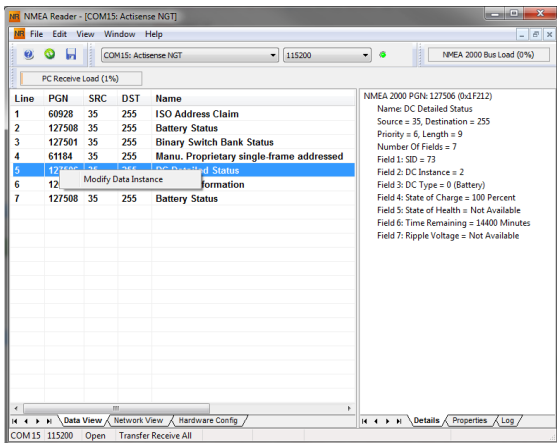

**Notes:**

- The Battery instance and the DC instance are the same value within Victron products. Changing one of them, will also change the other one.
- Since the BMV sends out two voltages, the main voltage and the aux- or starter-voltage, it comes preconfigured with two battery instances: 0 and 1. When you want to change that to 1 and 2, change the 1 into 2 first, and then the 0 into 1, as they cannot be the same.
- Changing the fluid level instance using Actisense has a bug. Probably due Actisense seeing it as 8 bit number; while in the definition it is a 4 bit number. Work around: using the GX, set the fluid type to Fuel (0), then using Actisense change the fluid instance to the desired value, and then using your GX, set the type back to the desired type.

**Maretron N2KAnalyzer:**

Maretron uses a term called “Unique Instance” where the N2KAnalyzer software tool automatically determines if a particular device uses Device or Data instances.



**WARNING:** At Victron we do not understand what and how the Maretron software works with regards to this. We advise to use another tool, not Maretron, so that you know what you are doing, ie know what instance you are changing. So far, we have not been able to use Maretron software to change a Data instance. And changing the other instance, the Device instance can also be done straight from the Victron GX device its user interface. To change a Data instance, for example to fix instance conflicts as reported by the Maretron software, we recommend to use Actisense. Not Maretron.

#### Changing the instances from the GX command line:

Instead of using Actisense or Maretron software, it is also possible to change the VE.Can aka N2K Device instance from the GX Device shell. To get root access, follow these instructions: [Venus OS: Root Access](#).

Once logged into the shell, follow below instructions. More back ground information of the used commands such as dbus and dbus-spy is found by reading about root access document.



**WARNING:** Better use an Actisense!

The procedure described in the following paragraphs is not normally recommended. Use an Actisense instead, see the Actisense method explained earlier.

#### New method - changing a Device instance:

All devices available on the canbus are enumerated under the *com.victronenergy.vecan* service. And for all devices that support the necessary can-bus commands, the Device instance can be changed. All Victron products support changing their Device instance; and most or all non-Victron products as well.

```
# dbus -y com.victronenergy.vecan.can0 / GetValue
value = {
  'Devices/00002CC001F4/DeviceInstance': 0,
  'Devices/00002CC001F4/FirmwareVersion': 'v2.73',
  'Devices/00002CC001F4/Manufacturer': 358,
  'Devices/00002CC001F4/ModelName': 'Cerbo GX',
  'Devices/00002CC001F4/N2kUniqueNumber': 500,
  'Devices/00002CC001F4/Nad': 149,
  'Devices/00002CC001F4/Serial': '0000500',
  'Devices/00002CC005EA/CustomName': 'Hub-1',
  'Devices/00002CC005EA/DeviceInstance': 0,
  'Devices/00002CC005EA/FirmwareVersion': 'v2.60-beta-29',
  'Devices/00002CC005EA/Manufacturer': 358,
  'Devices/00002CC005EA/ModelName': 'Color Control GX',
  'Devices/00002CC005EA/N2kUniqueNumber': 1514,
  'Devices/00002CC005EA/Nad': 11,
  'Devices/00002CC005EA/Serial': '0001514',
  'Devices/00002CC005EB/CustomName': 'SmartBMV',
  [and so forth]
```

To change them, do a SetValue call to the DeviceInstance path like below. Or, perhaps easier, use the dbus-spy tool.

These lines read it, then changes it to 1, then reads it again:

```
root@ccgx:~# dbus -y com.victronenergy.vecan.can0 /Devices/00002CC005EB/DeviceInstance GetValue
value = 0
root@ccgx:~# dbus -y com.victronenergy.vecan.can0 /Devices/00002CC005EB/DeviceInstance SetValue %1
retval = 0
root@ccgx:~# dbus -y com.victronenergy.vecan.can0 /Devices/00002CC005EB/DeviceInstance GetValue
value = 1
```

[note that numbers, like can0, and 00002CC005EB can ofcourse be different on your system].

#### New method - changing Data instance:

This applies only to the NMEA2000-out feature.

The Data instances used for the NMEA2000-out feature are stored in local settings. Here is a snippet of the lines, taken by using the dbus-spy tool that also allows changing entries (the Data instances are the “Battery-”, “DC Detailed-”, and so forth instances):

```
Settings/Vecan/can0/Forward/battery/256/BatteryInstance0      0      <- Data instance for main voltage measur
Settings/Vecan/can0/Forward/battery/256/BatteryInstance1      1      <- Data instance for starter or mid-volt
Settings/Vecan/can0/Forward/battery/256/Description2
```

```

Settings/Vecan/can0/Forward/battery/256/IdentityNumber      15
Settings/Vecan/can0/Forward/battery/256/Instance           1
Settings/Vecan/can0/Forward/battery/256/Nad                233    <- Source address - no need, also not go
Settings/Vecan/can0/Forward/battery/256/SwitchInstance1    0      <- Data instance for switchbank
Settings/Vecan/can0/Forward/battery/256/SystemInstance     0
Settings/Vecan/can0/Forward/solarcharger/0/DcDataInstance0 0
Settings/Vecan/can0/Forward/solarcharger/0/DcDataInstance1 1
Settings/Vecan/can0/Forward/solarcharger/0/Description2    0
Settings/Vecan/can0/Forward/solarcharger/0/IdentityNumber  25
Settings/Vecan/can0/Forward/solarcharger/0/Instance        0
Settings/Vecan/can0/Forward/solarcharger/0/Nad             36
Settings/Vecan/can0/Forward/solarcharger/0/SystemInsta    0
Settings/Vecan/can0/Forward/solarcharger/1/DcDataInstance0 0      <- Battery voltage & current
Settings/Vecan/can0/Forward/solarcharger/1/DcDataInstance1 1      <- PV voltage & current
Settings/Vecan/can0/Forward/solarcharger/1/Description2    0
Settings/Vecan/can0/Forward/solarcharger/1/IdentityNumber  24
Settings/Vecan/can0/Forward/solarcharger/1/Instance        0
Settings/Vecan/can0/Forward/solarcharger/1/Nad             36
Settings/Vecan/can0/Forward/solarcharger/1/SystemInstance  0
Settings/Vecan/can0/Forward/solarcharger/258/DcDataInstance0 0
Settings/Vecan/can0/Forward/solarcharger/258/DcDataInstance1 1
Settings/Vecan/can0/Forward/solarcharger/258/Description2  0
Settings/Vecan/can0/Forward/solarcharger/258/IdentityNumber 23
Settings/Vecan/can0/Forward/solarcharger/258/Instance      0
Settings/Vecan/can0/Forward/solarcharger/258/Nad           36
Settings/Vecan/can0/Forward/solarcharger/258/SystemInstance 0
    
```

**Old method:**

1. List the devices:

```

root@ccgx:~# dbus -y
com.victronenergy.bms.socketcan_can0_di0_uc10
com.victronenergy.charger.socketcan_can0_dil_uc12983
    
```

2. Change it, for example, to 4:

```

root@ccgx:~# dbus -y com.victronenergy.charger.socketcan_can0_di0_uc12983 /DeviceInstance SetValue %4
retval = 0
    
```

3. Wait a few seconds, and double check:

```

root@ccgx:~# dbus -y
com.victronenergy.bms.socketcan_can0_di0_uc10
com.victronenergy.charger.socketcan_can0_di4_uc12983
    
```

Device instance changed successful!

**14.8.6. PGN 60928 NAME Unique Identity Numbers**

The GX device will assign an individual Unique Identity Number to each Virtual-device. The number assigned is a function of the PGN 60928 NAME Unique Identity Number block aka Unique device number for VE.Can as configured in the settings of the GX device.

This table shows how changing that setting translates into the virtual-devices as made available on the CAN-bus:

Configured Unique Identity block:	1	2	3	4
GX device	500	1000	1500	2000
1st virtual-device (for example a BMV)	501	1001	1501	2001
2nd virtual-device (for example another BMV)	502	1002	1502	2002
3rd virtual-device (for example a third BMV)	503	1003	1503	2003

## 15. RV-C Support

### 15.1. RV-C Introduction

Starting with Venus OS firmware v2.90, Victron supports the RV-C protocol.

#### What is the RV-C protocol?

The RV-C (Recreation Vehicle-CAN) protocol is to RVs what NMEA 2000 (also known as N2K) is to boats: a communication protocol based on CAN-bus (Controller Area Network bus) and used primarily in RVs in the US to enable RV devices and appliances to communicate and work together.

There are two basic functions, RV-C out and RV-C in.

- RV-C out allows control and monitoring of compatible Victron devices from a RV-C control panel.
- RV-C in allows receiving data from one or more compatible RV-C devices to be displayed on the GX device.

In summary, when this feature is enabled with the GX device connected to an RV-C network, an RV-C control panel can read Victron data, e.g. from a BMV or an inverter/charger and display it to the user or even control some of them. Compatible RV-C devices are displayed on the GX unit at the same time.

RV-C is built upon [SAE J1939](#).

### 15.2. Limitations

#### VE.Can devices

The RV-C and VE.Can protocols are not compatible with each other: a VE.Can port on a GX device can be configured to the VE.Can profile or to the RV-C profile, not both at the same time.

Using a GX device with just one fully functional VE.Can port means that there is a limitation to what devices can be used in the system when connection to RV-C is a requirement.

Typical RV-related products, which therefore cannot be used in the situation described above:

- the Lynx Smart BMS cannot be used as it needs to be connected via VE.Can. Use a VE.Bus BMS instead (connects to the VE.Bus port).
- the Lynx Smart Shunt cannot be used, use a SmartShunt instead (connects via VE.Direct).
- the Wakespeed alternator regulator cannot be connected to the monitoring by the GX device.
- higher power MPPT charge controllers must be connected using their VE.Direct connection. Not on a VE.Can network.

Depending on the system, this currently also limits the selection of a suitable GX device:

- Color Control GX (CCGX), MultiPlus-II GX and EasySolar-II GX: has only one VE.Can port, thus it can be configured for either VE.Can or RV-C, not both. And because of this you can't for example make a system with a Lynx Smart BMS (which need to be connected on a VE.Can port) and have it connected to RV-C at the same time.
- Cerbo GX & Cerbo-S GX: current generation has only one (fully functional) VE.Can port. Same as above, it's either VE.Can or RV-C, not both.



Please note that the BMS-Can port on the Cerbo GX is limited and cannot be used as RV-C port.

- Venus GX: has two VE.Can ports. So can be connected to both, VE.Can and RV-C networks at the same time.
- Ekrano GX: has two VE.Can ports. So can be connected to both, VE.Can and RV-C networks at the same time.

### 15.3. Supported Devices

Venus v2.90 adds RV-C out support for the following products:

Victron product	Remarks
VE.Bus Inverter/Charger	The inverter and charger part can be controlled separately (on/off) from RV-C. Also shore input current limit can be set.



Victron product	Remarks
Smart IP43 Charger 120-240V	Can be activated/deactivated (on/off) via RV-C. Also shore input current limit can be set.
Smart IP43 Charger 230V	The Smart IP43 Charger 230V cannot be controlled and is read-only.
Skylla-i and Skylla-IP44/IP65	Note that this requires two fully functional CAN-bus interfaces. For the time being, only the Venus GX and the Ekrano GX has these two interfaces.
VE.Direct Inverter	
Inverter Smart and Inverter RS	
Solar chargers incl. MPPT RS	
Batteries: BMV, SmartShunt, Lynx Shunt, Lynx Ion BMS, Lynx Smart BMS	
Tanks; Tank level senders connected to: the tank level input of the GX device a GX Tank 140 the VE.Can and/or NMEA 2000 port of the GX device	

VenusOS also support RV-C in data for:

- RV-C tank sensors  
Please note that the Garnet SeeLevel II 709 does not have absolute tank level and tank capacity. Therefore we only show relative level. Tanks from another GX device will have absolute level and capacity, but cannot be configured through RV-C.
- RV-C batteries: Lithionics is the only supported RV-C battery (including DVCC support)

See the [Appendix \[132\]](#) for advanced parameters and RV-C programming.

## 15.4. RV-C Configuration

The configuration for RV-C is done via the GX device:

1. Open the remote console and go to Settings → Services → VE.Can ports → CAN-bus profile.
2. Open the CAN-bus profile and select the RV-C (250 kbit/s) profile.

The RV-C profile will start working and the previously selected profile will shut down (associated equipment like VE.Can devices become unavailable in the GUI).

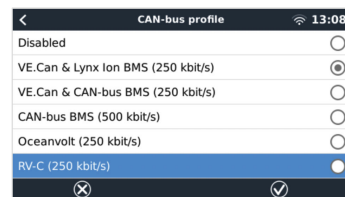
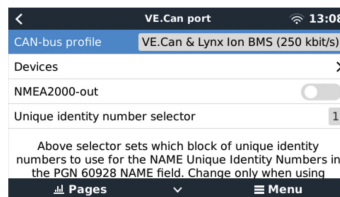
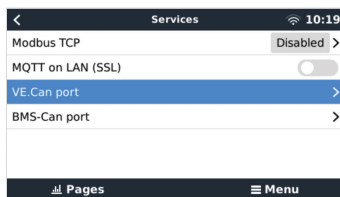



### 15.4.1. Configuration of RV-C out devices

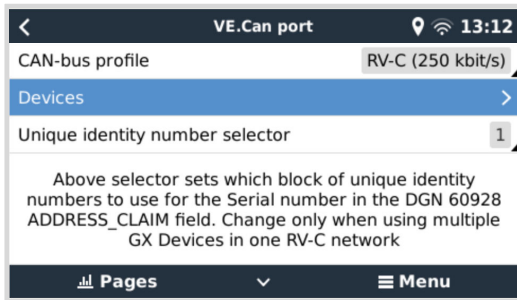

RV-C out devices can be configured from the Devices submenu in the VE.Can port menu.

The Devices submenu contains all devices of the RV-C network including RV-C out devices. The latter are identified by their [VRM# instance], which can be used to identify the "real" devices from the root menu of the GX device. The hexadecimal on the right hand side is the Source Address.

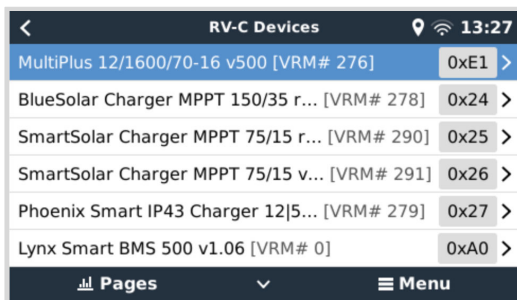

When you enter the submenu of an RV-C device, you will see general RV-C device information and more importantly the configuration menu if you scroll down to the bottom of the page. Viewing the configuration menu requires at least user and installer access level, see chapter [Menu structure and configurable parameters \[45\]](#).

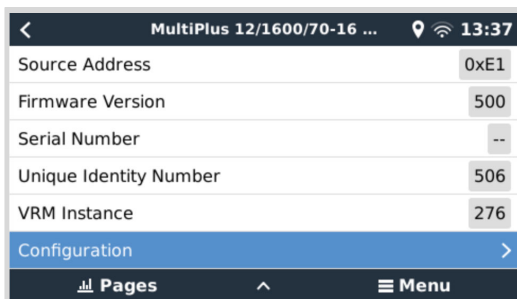

The instance for the corresponding DGNs can be changed in the Configuration submenu.

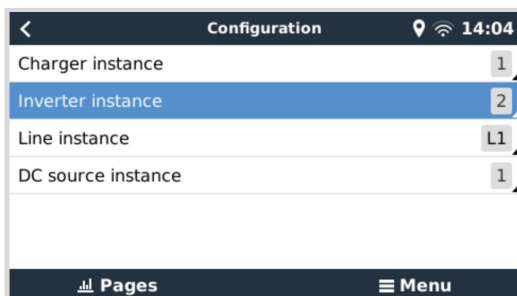

## 15.5. Garnet SeeLevel II 709-RVC & Victron GX device support

With RV-C support in Venus OS it is also possible to use the Garnet SeeLevel 709-RVC and display its data on the GX device and VRM. All 709-RVC models and the SeeLevel Soul are compatible with the GX.

Note the limitations as described in the [Limitations section \[109\]](#). This means that when using a CAN-bus port on the GX device for RV-C, it cannot be used for other purposes at the same time, such as the common VE.Can and NMEA 2000 features. It's either VE.Can/N2K or RV-C, unless it's a Venus GX or Ekrano GX, which have two full VE.Can ports. If this limits further use of the GX device too much in terms of connectivity via VE.Can, it is recommended to use the Garnet SeeLevel 709-N2K instead.

Also note that tank levels displayed on the Victron GX will be in percentage, not actual volume in liters, gallons, or any other unit of volume.

### 15.5.1. Wiring the Garnet SeeLevel II 709-RVC tank level sensor to a GX device

Before connecting to a GX device, ensure that the Garnet SeeLevel 709-RVC has been installed and configured correctly according to Garnet's installation instructions.

While the VE.Can port requires an RJ45 connector, the Garnet SeeLevel panel features either a multi-pin RV-C connector or wired connection with one black, one blue and one white wire each. In order to be able to connect both together, an adapter cable must be built according to the pin assignment in the table below.

A commercially available CAT5 Ethernet cable is best suited for this, whereby one of the two ends is first cut off and then connected to the Garnet panel.

Garnet panel wire colour code	RV-C connector	Victron VE.Can RJ45	CAT5 Ethernet wire colour code	Signal
Black	4	3	green/white	Ground
Blue	3	8	brown	CAN-L
White	2	7	brown/white	CAN-H

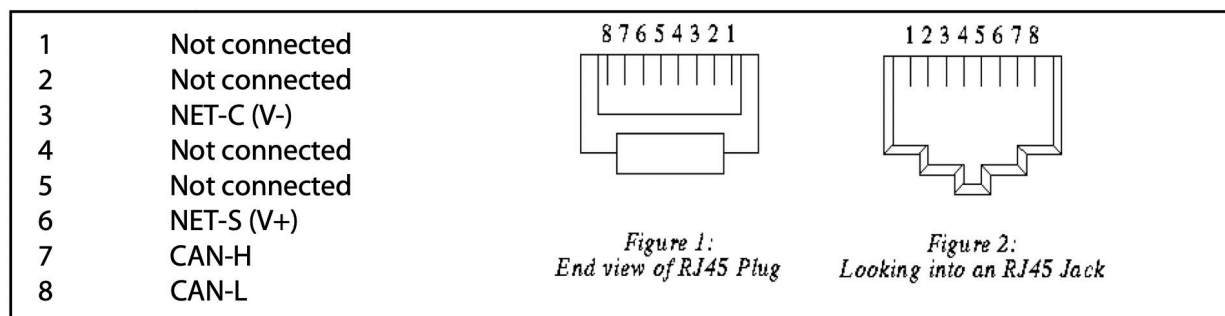

*Victron VE.Can pinout*

### 15.5.2. Installation and configuration

1. Route the cable from the Garnet panel to the GX device.
2. Make sure both the Garnet and the GX device are powered off.
3. Connect the RJ45 plug to the VE.Can port of the GX device and the other end of the adapter cable to the Garnet panel.
4. Make sure the bus termination is correct. For the GX device: Use the included blue [VE.Can RJ45 terminator](#). Proper bus termination is mandatory for the Garnet SeeLevel if it is the only RV-C device.
5. Once everything is installed correctly, turn on both devices.
6. Proceed with the RV-C configuration as explained in the [RV-C Configuration chapter \[110\]](#) to properly configure the VE.Can port for the RV-C profile.

## 16. GX - Generator auto start/stop

### 16.1. Generator auto start/stop introduction

An internal relay on a [GX device](#) (eg CCGX) can be used to automatically start and stop a generator. This relay - or switch - can be 'tripped' by a number of user-defined conditions. This chapter will explain what conditions are available to you; and it will guide you through the steps required to set up this useful functionality.

More general information about using a generator in combination with Victron is available in the [MultiPlus Generator FAQ](#).

### 16.2. Wiring

Firstly, wire the relay to a genset. The relay is located on the back of the CCGX - marked Relay. If using a Color Control GX, two relays will be seen at the bottom of the unit - only Relay 1 can be used for the generator automatic start/stop functionality.

Wiring between the CCGX and the generator needs to be 'permanent' in order for the generator to keep running; and also to allow automatic 'Stop' when the parameters for auto-stop have been met.

Besides driving the internal relay, the auto start/stop functionality can be also enabled to directly control supported Fischer Panda generators. For more information on how to connect Fischer Panda generators, see [GX - Fischer Panda generators](#) documentation.

There are many variations on the generator side for wiring and you should also consult your generator manual or supplier regarding their remote wire start configuration.

### 16.3. Enabling the start/stop function

Go to: Settings → Relay and set the function options to Generator start/stop

#### Relay



After activating this function, all the settings pertaining to the Automatic Generator start/stop function will be found in the main menu under: Settings → Generator start/stop.

#### Fischer Panda Generators

1. Enable the "AutoStart" function in the Fischer Panda generator control panel.
2. Go to the Fischer Panda Genset page and set the Mode setting to Auto start/stop.

Once the Mode is set, all settings will become available under the Auto start/stop menu entry at the bottom of the page.

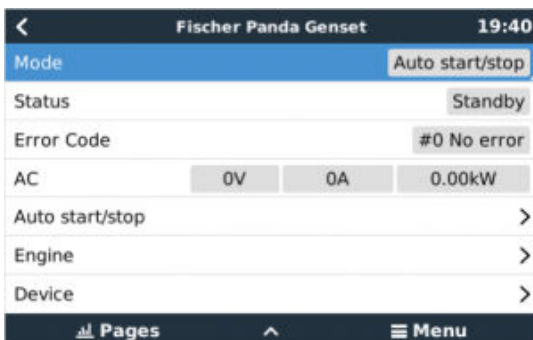

## 16.4. Generator start/stop menu

Go to Settings → Generator start/stop:

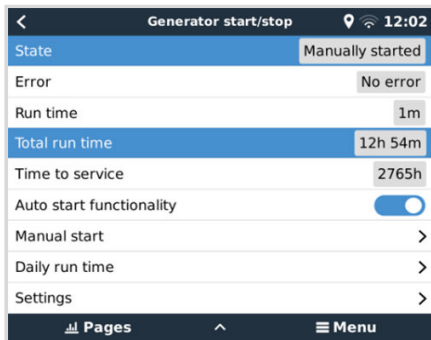

This is the general overview page of the generator start/stop function. This page can be used to monitor the generator's status, view the error status and history of the last 7 days, and make necessary settings.

To get to the overview page, go to Settings → Generator start/stop.

The individual menu items have the following functions:

- **State:** Displays the current status of the generator.  
Possible state messages:  
Stopped, Warm-up, Manually started, Running by condition, Cool-down, Stopping
- **Error:** Error description.
- **Run time:** Generator run time since last start.
- **Total run time:** Accumulated generator run time since the first start. This is also affected by the Total generator run time (hours) setting in the [Run Time and service interval menu \[115\]](#).
- **Time to service:** Displays the remaining time until the next service as defined in the [Run time and service interval menu \[115\]](#).
- **Auto start functionality:** Enables the generator auto start/stop function based on defined conditions set in the [Conditions menu \[116\]](#).
- **Manual start:** See the [Manual Start Feature \[118\]](#) section for details.
- **Daily run time:** Run-time history for the last 7 days.
- **Settings:** This is the gateway to all other features.

## 16.5. Settings menu

In the Generator start/stop menu, scroll down and press the spacebar on Settings to bring up the Settings menu.

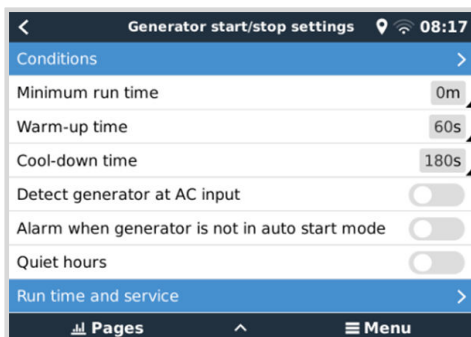

**Conditions:** See the [Conditions \[116\]](#) chapter.

**Minimum run time:** It's good practice for a generator, once started, to be allowed to reach its operating temperature. When started manually, this setting is ignored.

**Warm-up time and Cool-down time:** Allows a configurable time to be set for the generator to warm up or cool down via relay control while the AC input relay is open and the inverter/charger is not connected to it. Note that this feature requires an update of the VE.Bus inverter/charger to firmware 502 or later.

**Detect generator at AC input:** Enabling this feature will raise an alarm on the GX device, as well as trigger an alarm email from the VRM portal:

- whenever power is not detected at the AC input terminal of the Inverter/Charger. This function will bring attention to a wide variety of problems; such as lack of fuel, or a mechanical or electrical fault at the generator. This functionality is not available for VE.Can connected Multi/Quattros.
- It requires automatic alarm monitoring on VRM to be enabled, which it is by default.

**Alarm when generator is not in auto start mode:** See the [Alarm when generator is not in autostart mode section \[115\]](#) for details.

**Quiet hours:** See the [Quiet hours section \[119\]](#) in the [Conditions chapter \[116\]](#).

**Run time and service:** See the [Run time and service interval menu \[115\]](#) for details.

### 16.5.1. Alarm when autostart function is disabled

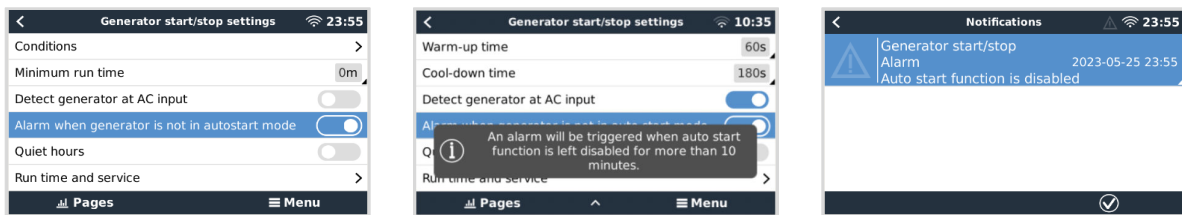

If this option is enabled, an alarm will be triggered when the autostart function is left disabled for more than 10 minutes. This is particularly useful when the generator has just been serviced, and the service technician has forgotten to put the generator back into autostart mode.

### 16.5.2. Run time and service interval menu

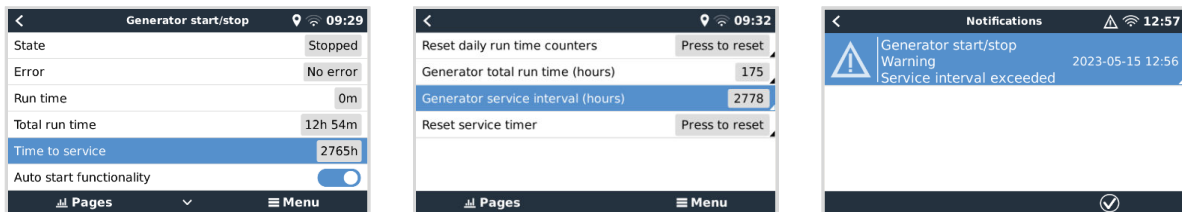

Every generator has to be serviced after a certain period of time. The recommended maintenance frequency of a generator depends in particular on its use and run time. This time interval can be set via this menu, which then starts a counter that generates a warning to indicate the necessary service when it expires.

The menu items in detail:

**Reset daily run time counters:** Resets the 7-day run-time history.

**Generator total run time (hours):** Reset or change the total run time hours to match those in the generator. This also affects the 'Total run time' display in the generator start/stop overview.

**Generator service interval (hours):** Set the service interval (in hours) for the generator. Check the generator manual for specific instructions.

**Reset service timer:** Resets the service timer. Use this option after the generator has been serviced to allow the 'Time to service' counter to start again.

## 16.6. Conditions: User definable parameters that trigger an automatic generator start/stop

To get to Conditions from the main menu go to: Settings → Generator start/stop → Settings → Conditions

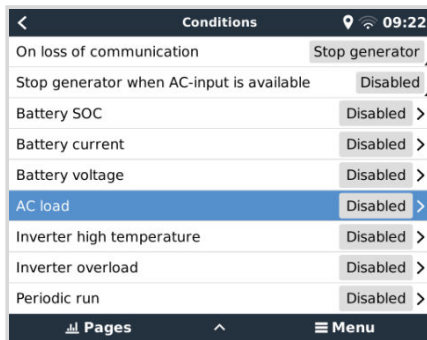

**On loss of communication:** If ever there is a communication breakdown between the CCGX and the VE. Bus inverter/charger; and parameters have been set which depend on this information - choose between the following actions:

- **Stop the generator:** If the generator is running, it will be stopped (default).
- **Start the generator:** If the generator is not running, it will be started.
- **Keep running:** If the generator is running at the time of data loss, this setting will keep it running.

**Stop generator when AC-input is available:** This option is ideal for backup systems where a Quattro has mains/grid electricity connected to its AC-in 1 or AC-in 2 terminal and a Genset connected to the other AC-in terminal. If this option is activated, the Genset will not stop until mains voltage is restored after a mains failure. This functionality is not available for VE.Can connected Quattros.

The following parameters may be user-defined to trigger an automatic generator start/stop:

- [Manual \[118\]](#)
- [Stop generator when AC-input is available \[116\]](#)
- [Battery SoC \[117\]](#)
- [AC load\\* \[117\]](#)
- [Battery current \[117\]](#)
- [Battery voltage \[117\]](#)
- [Inverter high temperature \[118\]](#)
- [Inverter overload \[118\]](#)
- [Periodic run \[118\]](#)

(\* The value measured here will be the total AC consumption of the system.)

Condition-parameters are prioritised in the order shown above. When a number of conditions are reached at the same time, only the highest-priority condition will be shown as active. All enabled conditions will be evaluated - even if the generator is already running. When the active condition has been satisfied, an un-met parameter in a lower-priority condition will keep the generator running.

### 16.6.1. Stop generator when AC-input is available

This option is ideal for backup systems where a Quattro has one AC input connected to mains power and the other AC input connected to a generator. If this option is activated and the AC input to which the grid is connected has been defined, the generator stops as soon as the grid is available again after a grid failure. In this case, the generator is first disconnected. The generator is then given the configured cool-down time before shutting it off. An additional 15 seconds is allowed for the generator to complete the process.

- **Disabled:** Stop generator when AC-input is available is currently disabled
- **AC input 1:** Mains power is connected to AC input 1
- **AC input 2:** Mains power is connected to AC input 2

### 16.6.2. Relays triggered by Battery SoC

- **Use Battery SoC value to start/stop:** Toggle this feature on or off.
- **Start when Battery SoC is lower than:** Set the depletion level for autostart.
- **Start value during quiet hours:** During *Quiet hours* it may be desirable to delay an autostart until it really can't be avoided. If *Quiet hours* has been defined, set a lower, more critical autostart level.
- **Stop when Battery SoC is higher than:** Set the recharge level for autostop.
- **Stop value during quiet hours:** If *Quiet hours* has been defined, set a lower autostop level to achieve a shorter generator run-time.

### 16.6.3. Relays triggered by Battery Current

- **Use battery voltage value to start/stop:** Toggle the feature on or off.
- **Start when battery voltage is lower than:** When a high AC demand is experienced which will soon exhaust the battery, the generator can be auto-started to assist in meeting that demand. Set the current-level at which this will occur.
- **Start value during quiet hours:** If *Quiet hours* has been defined, set a higher, more critical current value.
- **Start after condition is reached for:** Set a delay before autostart. Some AC device will draw a short-term, high-peak current on startup. Instigating a delay before autostart will avoid starting the generator unnecessarily.
- **Stop when battery current is lower than:** Set the current for autostop.
- **Stop value during quiet hours:** If *Quiet hours* has been defined, set a higher current level to achieve shorter generator run-times.
- **Stop after the condition is reached for:** Set a delay to ensure that the current-reduction condition is stable.

### 16.6.4. Relays triggered by Battery Voltage

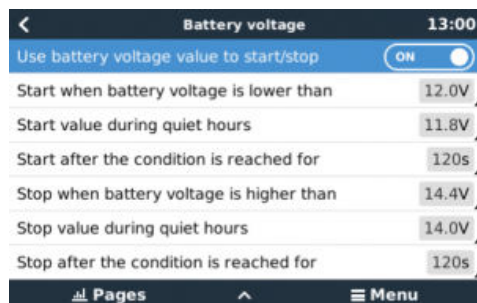

- **Use battery voltage value to start/stop:** Toggle the feature on or off.
- **Start when battery voltage is lower than:** When battery voltage falls below the value entered, the relay will start the generator.
- **Start value during quiet hours:** If *Quiet hours* has been defined, enter a lower (more critical) value to ensure the generator will only autostart when absolutely necessary.
- **Stop after the condition is reached for:** This feature builds in a delay before stopping the generator after the 'stop' value has been reached. This is to make sure that the voltage rise is stable.

### 16.6.5. Relays triggered by AC load

AC load triggers work similarly to other triggers but the feature is refined by a Measurement setting. The Measurement setting is available on firmware v2.0 and later and has three possible values:

1. Total consumption (Default option)
2. Inverter total AC out
3. Inverter AC out highest phase

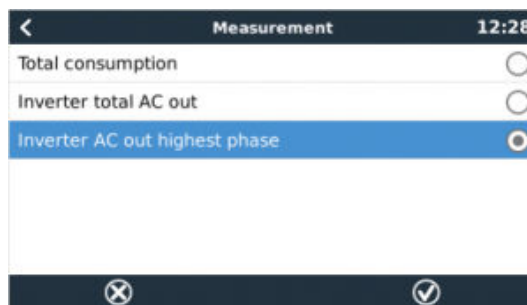
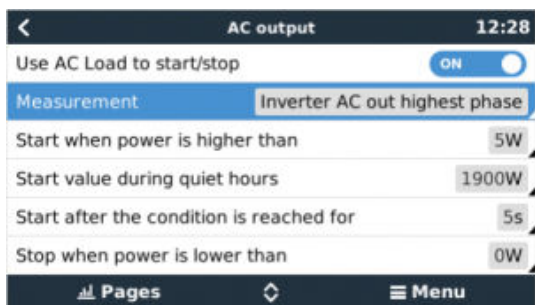

### 16.6.6. Relays triggered by Inverter High temperature

- **Start on high temperature warning:** Toggle this feature on or off.
- **Start when warning is active for:** Set a delay to avoid temperature rises which are temporary, caused by brief high AC demands.
- **When warning is cleared stop after:** Set a delay to ensure that a reduction in inverter temperature - usually caused by lower power demand - is stable.

### 16.6.7. Relays triggered by Inverter overload

- **Start on overload warning:** Toggle this feature on or off.
- **Start when warning is active for:** Set a delay to ensure that the inverter overload warning has not been triggered by a high-demand of AC power of only short duration.
- **When warning is cleared stop after:** Set a delay to ensure that the reduction in AC power demand is stable.

### 16.6.8. Automatic periodic 'Test run'

This feature allows automatic generator starts, periodically, as a 'test run'.

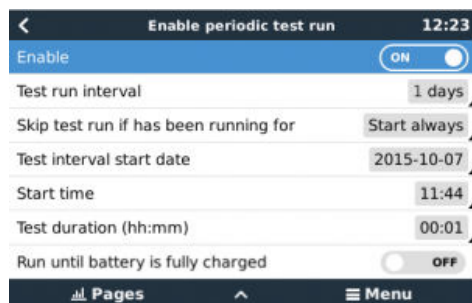

- **Test run interval:** Set the interval between test runs.
- **Skip test run if has been running for:** The test will be skipped if during the test run interval the generator ran for at least as long as it would on a 'test run'.
- **Test interval start date:** The 'test run' interval counter will start from the date entered here. No test runs will be carried out until the date set here has been reached.
- **Start time:** Time of day at which the generator 'test run' will commence.
- **Test duration:** Duration of the test.
- **Run until battery is fully charged:** Enabling this feature will cause the 'test run' to continue until the battery is fully charged - instead of for a fixed amount of time.

### 16.6.9. Manual Start Feature

Use the Manual start feature to remotely start the generator. You can also press Start when the generator is already running - doing so will ensure that the generator won't automatically stop when the condition which caused it to start has been satisfied. In other words, the Manual start feature will override the autostop parameters.

There are two ways to start the generator manually:

1. **Using the Manual start menu:** Go to Generator start/stop → Manual start; and then toggle the graphic to start the generator.



- Using the GX 'Home page' Generator graphic:** Press the top-left button on the CCGX, or Color Control GX Remote Console and engage the Generator page. Then press the center button. You must first choose how you wish to stop the generator - manually, or by entering a run-time. Once you've made your selection a five-second countdown will begin during which you can abort the manual start by pressing the center button.

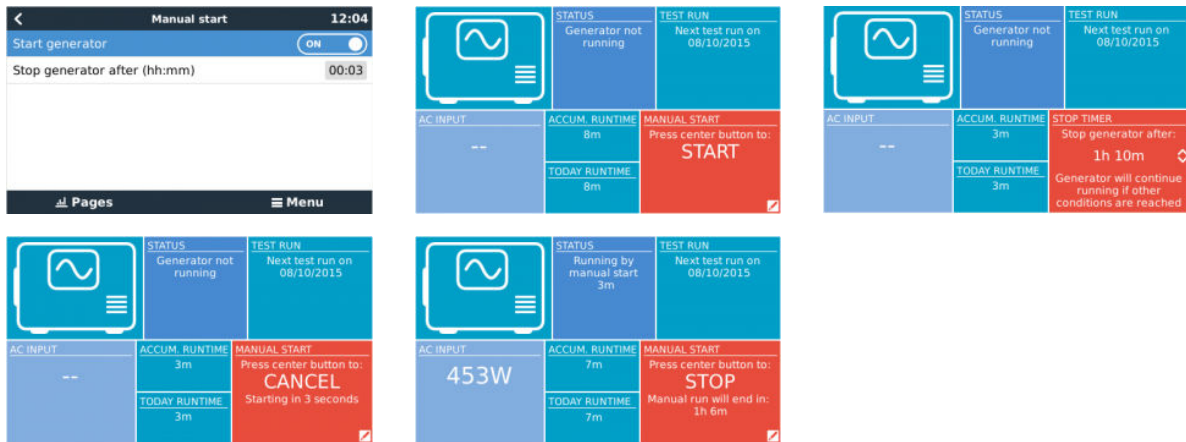

**WARNING:** If the generator is started manually (remotely) without using the stop timer, it will run until the 'Off' button has also been manually toggled.

The stop timer is available to both methods of manually remote-starting the generator, and using it will ensure that the generator will autostop ...and will not be inadvertently forgotten.

Note that stopping the generator manually can only be achieved when no un-met 'run' condition is active. If you wish to force a generator-stop you must first disable the function which is keeping it running - or disable the Generator start/stop function.

### 16.6.10. Quiet hours

*Quiet hours* allows you to define a period during which the noise from a running generator would be a nuisance; and to set different values to the conditions which would cause an autostart during this period - thus ensuring that the generator will only start during a quiet period when it is absolutely necessary.

From the main menu go to Settings → Generator start/stop → Settings; and then toggle-on the *Quiet hours* feature. Define the *Quiet hours* start- and end- times in the boxes which appear below.

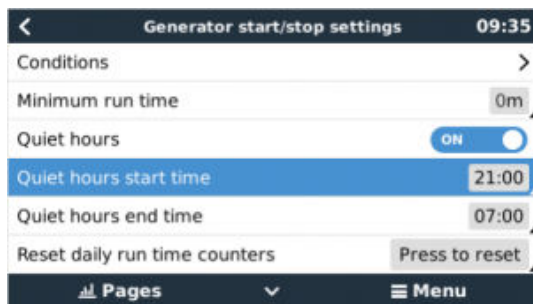

*Quiet hours* will become the permanent condition (when enabled) if the defined 'start' and 'stop' times are the same.

#### Using Quiet hours as a tool to define two sets of user-preferences

Alternatively, the *Quiet hours* feature can be used to define how you wish your system to respond to different circumstances - for example:

- Early morning/low SoC:** Battery SoC is often lowest in the morning. Couple this with cloudy weather first thing - or panels which have a westerly bias, and which tend to do better in the afternoon; and you have a circumstance where the generator may autostart in the morning triggered by a low battery SoC condition - yet later on when the day brightens, the solar energy is wasted because the work has already been done by the generator. Setting the *Quiet hours* feature to cover this period, together with lower autostart conditions, will help to avoid unnecessary generator autostarts.
- Holiday home:** Holiday homes which are only inhabited part-time experience much deeper power-draws when they are in use. The *Quiet hours* feature can be used to set much lower autostart parameters when the house is in use than when it is empty. *Quiet hours* should be set to be the permanent condition (see above) during occupation; and the *Quiet hours* feature can be toggled 'off' whenever the house is empty.

## 16.7. Troubleshooting

### **Fischer Panda: Generator does not start and "Remote switch control disabled" error is shown**

Enable the "AutoStart" function in the Fischer Panda control panel.

### **Fischer Panda: Auto start/stop function has stopped working after an error**

Make sure that the issue is solved, then clear the error, and the auto start/stop function will work again.

## 17. Reset to factory defaults and Venus OS reinstall

### 17.1. Reset to factory defaults procedure

A GX device factory reset is performed by inserting a USB stick or SD card with the specific reset file on it.

Factory reset requires Venus firmware version 2.12 or higher. It does not require any buttons or a screen to perform.

#### How to reset a GX device to factory default settings:

1. Download the [venus-data-90-reset-all.tgz](#) file.
2. Copy the file onto a blank, freshly formatted FAT32 USB-drive/SD card (don't unpack or unzip that file, don't rename it ).  
If the GX device is running firmware between versions 2.12 and 3.10, only executing a single file is supported. Either update the firmware on the GX device first or rename the downloaded file to `venus-data.tgz` before putting it on the removable media.
3. Boot with the USB-drive/SD card inserted and wait until the GX device has fully started up.
4. Remove the USB-drive/SD card from the GX device.
5. Power cycle the device, or, alternatively and when available, use the Reboot function in the Settings → General menu.

This will reset the settings on the GX device to their factory defaults.

There are several technical reasons to do this, such as:

- If the device has been locked out by setting and then forgetting the Remote Console password on a model which doesn't have a screen.
- Customer has no issue but wants to have a clean start.
- A GX device has been used in a testing environment, and the service technician wants to remove the residual memory of that (such as discovered AC PV inverters).
- The GX device is performing strangely, and a reset to default may eliminate the possibility of a misconfigured setting.
- Data partition is full; this should only occur when someone has modified their device.
- Some unexpected bug, most likely only occurring in beta testing versions.



Previously saved Wifi access credentials will be reset - for devices without a physical interface and using WiFi to connect, consider how you will get access again to reconfigure.

You may also need to reset the VRM authorisation token after performing a factory reset. After the reset, open the site in VRM - if a token reset is required, there will be a notification in VRM and you can follow the instructions provided in there.

The factory reset does NOT modify the VRM site ID, or data that is stored on the VRM. If you wish to sell your GX device to someone else, or install it into another system and want to clear the history, you can do this in the VRM Portal by selecting the Site settings -> General -> Delete this installation.

### 17.2. Venus OS reinstall

Use this when the procedure described in [Reset to factory defaults procedure \[121\]](#) doesn't work.

#### WARNINGS:

- Before performing this procedure, first try the standard factory reset procedure as described in the previous section.
- Only perform this procedure as a last resort: to fix a bricked device. A device that boots fine but has some strange behaviour in some features will not benefit from executing this procedure.
- This procedure will wipe all data on the data partition, which means all settings and so forth.
- Unlike the common reset to factory default instructions, this procedure does not rely on a properly booting device.
- On the VRM Portal you'll have to reset the Device token. The portal will accept no new data until that is done.

- Ensure you have the appropriate manual for your GX device, as the procedures may vary slightly depending on the GX model.

**PROCEDURE:**

1. Download the upgrade image here: <https://updates.victronenergy.com/feeds/venus/release/images/ccgx/> (venus-upgrade-image-ccgx-\*.sdcard.zip)
2. Format the microSD card or USB flash drive as a FAT32 filesystem.
3. Extract the contents of the archive to the microSD or USB drive. Do not use a Flash application (like Balena Etcher) for this.
4. Insert the microSD card or USB flash drive into the CCGX device.
5. Press and hold the left button of the five-button central pad.
6. Power up the CCGX device; the update process will now start, and progress will be reported on the LCD display.
7. Release the button and wait for the process to finish. You will be asked to remove the installation medium (Micro SD card) and to power-cycle the system.

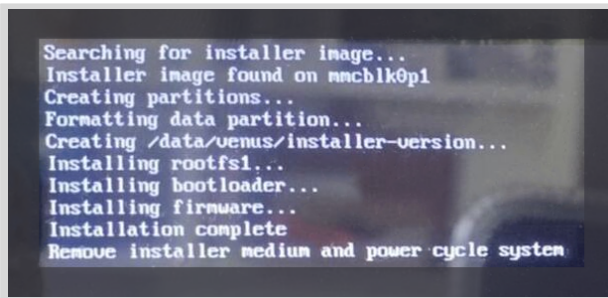

8. Remove the microSD card or USB drive and power-cycle the CCGX device.

## 18. Troubleshooting

### 18.1. Error Codes

#### Different origins of errors

On your GX device, some error codes shown will be from the GX device itself; in that case, see list below. As the system control panel, it also shows error codes from the connected devices, such as:

- Multi and Quattro inverterchargers: [VE.Bus Error Codes](#)
- MPPT Solar Chargers: [MPPT Solar Charger Error Codes](#)

#### GX Error #42 - Storage corrupt

- This error means that the flash memory inside the GX device is corrupt.
- The device must be sent in for repair/replacement. It is not possible to correct this issue in the field or with a firmware update.
- The affected flash memory is the partition that holds all user settings and factory data, such as serial numbers and WiFi codes.

#### GX Error #47 - Data partition issue

- The internal storage in the GX device is most likely broken: causing it to lose its configuration.
- Contact your dealer or installer; see our [Victron Energy Support](#) page.

#### GX Error #48 - DVCC with incompatible firmware

This error is raised when the DVCC feature is enabled, whilst not all devices in the system are updated to recent enough firmware. More information about DVCC and minimal required firmware versions in the [DVCC chapter \[67\]](#) of this manual.

##### • Note for systems with Pylontech and BMZ batteries:

In VenusOS v2.80, we enforced DVCC on for Pylontech and BMZ batteries. For very old and never updated systems, this can cause the same error.

Solution:

- Disable automatic updates; Settings → Firmware → Online updates.
- Revert to v2.73. To roll back to a previous firmware version, see [Install a specific firmware version from SD/USB \[61\]](#).
- And after that, consider getting an installer that will update all the firmware.

##### • Note for systems with BYD, MG Energy Systems and Victron Lynx Ion BMS batteries:

Since Venus OS v2.40, released in December 2019, the DVCC feature is automatically switched on when the system detects a supported battery/BMS type connected. In systems that require DVCC to be enabled by the battery manufacturers, it is no longer possible to switch DVCC off.

This creates an issue for systems installed and commissioned a long time ago before DVCC was available, and they may not have the other necessary components or firmware to work correctly with it enabled.

Solution:

- Disable automatic updates; Settings → Firmware → Online updates.
- Roll back to v2.33; to roll back to a previous firmware version, see [Install a specific firmware version from SD/USB \[61\]](#).
- Make sure that DVCC is disabled again.

Please consult your installer to check if the battery system is managed with two wire control (an earlier alternative control method to DVCC) or not:

If there is no charge- and discharge-wiring between BMS, inverterchargers and charge controllers, then DVCC is required for the above-mentioned battery brands, and this also has certain minimum firmware requirements for connected Inverterchargers and Solar charge controllers.

#### GX Error #49 - Grid meter not found

This warning is raised in an ESS system when Grid metering is configured to use an External meter, but no meter is present. This alerts installers and end-users that the system is not correctly configured or cannot operate correctly because it cannot communicate with the grid meter.

#### GX Error #51 - mk3 firmware needs update

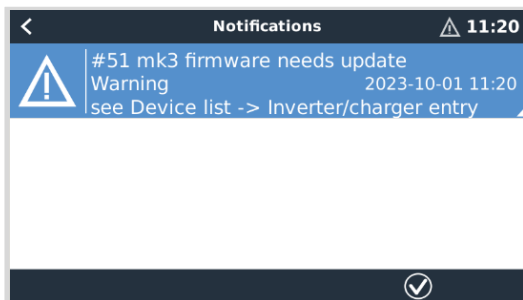

When this notification shows, it is recommended to update the MK3-controller that is embedded into the GX device. This update is required for recent new features, including Generator start/stop warmup and cooldown times.

To do that, go into the Device list, and then into the MultiPlus-Quattro or EasySolar listing. Here you will see this entry:

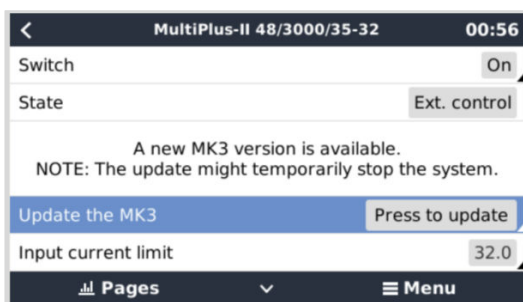

There is a small chance; our statistics show approx. 5% that this update triggers a short system restart: your inverter/charger might turn off and on again.

If you don't see that message, the system is already up to date. Note that this manual update is only needed once. It was made to be manually initiated because of the small chance of the inverter/charger restart. Future updates can be installed without sometimes resulting in a short restart.

## 18.2. FAQ

### 18.2.1. Q1: I cannot switch my Multi/Quattro system on or off

To solve the problem, first find out how the system is connected, and then follow the right step by step instruction below. There are two ways to connect a Multi/Quattro system to a Color Control GX. In most systems they will be connected directly to the VE.Bus port on the back of the CCGX. And, option two, in some systems they are connected to the Color Control GX using a VE.Bus to VE.Can interface.

#### Step by step instructions when connected to VE.Bus port on the CCGX

1. Update the Color Control GX to the latest available version.  
See our blog posts in the <https://www.victronenergy.com/blog/category/firmware-software/>.
2. Do you have a Digital Multi Control or VE.Bus BMS in the system? In that case it is normal that on/off is disabled.  
See also the VE.Bus related notes in the [CCGX manual \[8\]](#).
3. In case you have had a Digital Multi Control or VE.Bus BMS connected to your system, the Color Control GX remembers it and even when those accessories have been removed, the On/Off switch will still be disabled. To clear the memory, execute a Redetect system in the Remote Console menu for your Multi or Quattro.  
For details see the [Advanced menu \[64\]](#) section.
4. For parallel/three-phase systems consisting of more than 5 units: depending on temperature and other circumstances, it might not be possible to switch a system back on after switching it off with the CCGX. As a work around you'll need to unplug the VE.Bus cable from the back of the CCGX. And plug it back in after starting the VE.Bus system. The real resolution is to install the "CCGX dongle for large VE.Bus systems", partnumber BPP900300100. For details, read its [connection instruction](#).

#### Step by step instructions when connected to CCGX via VE.Can.

1. Update the Color Control GX to the latest available version. See our blog posts in the firmware category.
2. Update the VE.Bus to VE.Can interface to the latest version. The easiest way to do that is by using Remote firmware update: having a special piece of hardware, the CANUSB, is then not necessary.

3. Do you have a Digital Multi Control or VE.Bus BMS in the system? In that case it is normal that on/off is disabled. See also the VE.Bus related notes in the CCGX manual
4. In case you have had a Digital Multi Control or VE.Bus BMS connected to your system, and it is now no longer connected, the Canbus interface remembers it. Therefore, even after those accessories have been removed, the On/off switch will still be disabled. Clearing this memory is unfortunately not possible yourself, please contact us so we can help you.

#### **18.2.2. Q2: Do I need a BMV to see proper battery state of charge?**

It depends. For details see the [Battery state of charge \(SoC\) \[52\]](#) chapter.

#### **18.2.3. Q3: I have no internet, where can I insert a SIM card?**

There is no 3G or 4G modem in the GX device, and therefore also no slot for a SIM card. Go to a local store and buy a 3G/4G router with Ethernet ports. More information in the blog post link below and particularly in the comments section, as more users try differing equipment:

<https://www.victronenergy.com/blog/2014/03/09/off-grid-color-control-gx-to-vmr-portal-connectivity/>

#### **18.2.4. Q4: Can I connect both a GX Device and a VGR2/VER to a Multi/Inverter/Quattro?**

No. Also, instead of this combination, we recommend to use the Color Control GX, and add a 3G/4G or similar mobile router. See [Internet connectivity \[37\]](#).

#### **18.2.5. Q5: Can I connect multiple Color Control GX to a Multi/Inverter/Quattro?**

No.

### 18.2.6. Q6: I see incorrect current (amps) or power readings on my CCGX

Examples are:

- I know that a load is drawing 40W from the Multi, but the CCGX shows 10W or even 0W.
- I see that the Multi is supplying a load with 2000W, while in inverter mode, but from the battery only 1850W is being taken. Is those 150W coming out of nowhere?

The general answer is: the Multi and Quattros are not measurement instruments, they are inverter/chargers, and the measurements shown are a best effort delivery.

In more detail, there are several causes for measurement inaccuracies:

1. Part of the power taken from a battery by the inverter is being lost in the inverter, converted into heat: efficiency losses.
2. The Multi does not really measure the power being drawn from the battery. It measures the current at the output of the inverter, and then makes an assumption of the power being drawn from the battery.
3. Watts vs VA: depending on the Multi/Quattro firmware version and also the CCGX firmware version, you are either looking at VAs (the result of calculating AC voltage \* AC current) or looking at a Watts measurement. To see WATTS on the CCGX, update your CCGX to the latest version (v1.21 or newer). Also make sure the firmware version in your Multi supports Watts readout, minimum versions are xxxx154, xxxx205 and xxxx300.
4. Multis/Quattros connected to the CCGX via a VE.Bus to VE.Can interface will always reports VAs, not (yet) Watts.
5. If a current sensor assistant is loaded in a Multi/Quattro and no sensor is connected it will return invalid power / kWh values.
6. If a current sensor assistant is loaded in a Multi/Quattro make sure the position is set correctly and the scale match with the dipswitches on the sensor itself.
7. A current sensor assistant measures and reports VAs, not Watts.

Notes for systems with multiple units in parallel:

1. CCGX version prior to v1.20 use the power and current reported by the master of a phase and multiplied that by the number of devices in that phase. Since version v1.20 the values of all device is summed per phase and hence should be more accurate.
2. This revealed a bug for in the firmware of the multi when running in parallel. Ccgx v1.21 workarounds this, by falling back to the original behavior when it sees an affected firmware version. For better readings the multi's should be updated. The bug has been fixed in VE.Bus firmware version xxxx159, xxxx209, xxxx306. That firmware was released on February 17th 2015.
3. Multi firmware versions since 26xx207 / xxxx300 can also freeze the Power values at a certain moment in time.

Tips to prevent measurement problems:

1. Do not connect VEConfigure while the CCGX is connected
2. VE.Bus is not a 100% plug and play system: if you disconnect the CCGX from one Multi, and very quickly connect it to another, it can result it wrong values. To make sure that this is not the case, use the 'redetect system' option in the Multi/Quattro menu on the CCGX.

### 18.2.7. Q7: There is a menu entry named "Multi" instead of the VE.Bus product name

A VE.Bus system can be completely turned off, including its communication. If you turn a VE.Bus system off, and thereafter reset the CCGX, the CCGX cannot obtain the detailed product name and shows "Multi" instead.

To get the proper name again, go into the Multi menu on the CCGX and set the Switch menu entry to On or in case a Digital Multi Control is present, set the physical switch to On. Note that when there is a BMS, above procedure only works when within battery working voltages.

### 18.2.8. Q8: There is a menu entry named "Multi", while there is no Inverter, Multi or Quattro connected

If a CCGX ever saw a VE.Bus BMS or Digital Multi Control (DMC), it will remember them, until 'Redetect system' is started from the CCGX menu. After a minute, restart the CCGX: Settings → General → Reboot.



### 18.2.9. Q9: When I type the IP address of the Color Control GX into my browser, I see a web page mentioning Hiawatha?

Our plan is to at least run a website where you can change settings and see the current status. If all works out as we would like to, there might come be a fully functional version of the online VRM Portal running locally on the Color Control GX. This allows people without an internet connection, or an intermittent internet connection to have the same features and functionality.

### 18.2.10. Q10: I have multiple Solar chargers MPPT 150/70 running in parallel. From which one will I see the relay status in the CCGX menu?

From a random one.

### 18.2.11. Q11: How long should an automatic update take?

The size of the download typically is around 90MB. After download it will install the files which can take up to 5 minutes.

### 18.2.12. Q12: I have a VGR with IO Extender, how can I replace this with a Color Control GX?

It is not yet possible to replace the IO Extender functionality.

### 18.2.13. Q13: Can I use Remote VEConfigure, as I was doing with the VGR2?

Yes, see [VE Power Setup manual](#)

### 18.2.14. Q14: The Blue Power Panel could be powered through the VE.Net network, can I also do that with a Color Control GX?

No, a Color Control GX always needs to be powered itself.

### 18.2.15. Q15: What type of networking is used by the Color Control GX (TCP and UDP ports)?

#### Basics:

- The Color Control GX needs to have a valid IP address including a working DNS server and gateway. By default obtained from a DHCP server. Manual configuration is also possible.
- DNS port 53 UDP and TCP
- NTP (time sync) UDP port 123. NTP uses a pool of servers provided by [ntp.org](http://ntp.org), so this will connect to a wide variety of servers.

#### VRM Portal:

- Data is transmitted to the VRM Portal via HTTPS POST and GET requests to <http://ccgxlogging.victronenergy.com> on port 443. There is an option in the menu to use HTTP instead, port 80. Note that in that case it will still send sensitive data such as Remote Console related access keys over HTTPS/443.

#### Firmware updates:

- The CCGX connects to <https://updates.victronenergy.com/> on port 443.

#### Remote support and Remote Console on VRM:

- An outbound reverse SSH connection is made to [supporthosts.victronenergy.com](http://supporthosts.victronenergy.com) when either one, or both, of those features are enabled. The [supporthosts.victronenergy.com](http://supporthosts.victronenergy.com) record resolves to multiple IP addresses, and the DNS uses Geo-Location to resolve it to the nearest server. This outbound SSH connection tries multiple ports: port 22, port 80 or port 443. The first that works is used, and in case it loses connection it will retry them all again.
- No port forwarding or other internet router configuration is necessary to use these features.
- More information about the Remote Support feature is in the next FAQ item.
- More information about troubleshooting Remote Console on VRM is in here: [Remote Console on VRM - Troubleshooting \[81\]](#).

#### Two way communication (Remote VEConfig and Remote Firmware updates):

- Pre-v2.20: Uses HTTPS (port 443) to the Pubnub servers
- v2.20 and later: connects to [mqtt-rpc.victronenergy.com](http://mqtt-rpc.victronenergy.com) on port 443; and also connects to the [mqtt{1 to 128}.victronenergy.com](http://mqtt{1 to 128}.victronenergy.com) server farm. See this document for more information.

**MQTT on LAN:**

- When enabled, a local MQTT broker is started, which accepts TCP connections on port 8883 (SSL) and 1883 (Plain text).
- Depending on, the CCGX will also (try to) connect to the Victron MQTT cloud servers. This connection always uses SSL and port 8883.

**Remote Console on LAN:**

- Remote Console on LAN requires port 80 (small website hosted the GX device). And also requires port 81, which is the listening port for the websocket tunnel to VNC.

**Modbus TCP:**

- When enabled, the ModbusTCP server listens on the common designated port for Modbus TCP, which is 502.

**SSH Root Access:**

- Port 22 - see the [Venus OS root access documentation](#).
- This is a software developers feature.

**18.2.16. Q16: What is the functionality behind the menu item Remote support (SSH) in the Ethernet menu?**

When enabled, the Color Control GX will open a SSH connection to our secure server, with a reverse tunnel back to the Color Control GX. Through this tunnel, Victron engineers can login to your Color Control GX and perform remote support. This works when the Color Control GX is installed on an internet connection. The connection will even work when installed behind a firewall.

The SSH connection will be outbound, to port 80, 22 or 443 to [supporthosts.victronenergy.com](https://supporthosts.victronenergy.com), which resolves to multiple IP addresses and depends on your location. Remote support functionality is disabled by default.

**18.2.17. Q17: I don't see support for VE.Net products in the list, is that still coming?**

No.

**18.2.18. Q18: What is the data usage of the Color Control GX?**

Data usage depends heavily on amount of connected products, and behavior and usage of those products. The measurements below are an indication only, and taken from a system with one CCGX, one Multi, one BMV and one MPPT. Log interval set to 15 minutes. If you are on an expensive data-plan, do make some fail-safe.

Data consumption per month:

- VRM logging: 15MB download, 45MB upload
- Remote support: 22MB download, 40MB upload
- Update checks: 8MB download, 0.3MB upload (This does not include the update itself)
- 2 way communication: 26MB download, 48MB upload

Mentioned megabytes do not include the download of a Color Control GX firmware update. Firmware updates of 60MB are not uncommon.

**18.2.19. Q19: How many AC Current Sensors can I connect in one VE.Bus system?**

The current maximum is 9 sensors (since Color Control GX v1.31). Note that each need to be configured separately with an assistant in the Multi or Quattro to which it is wired.

**18.2.20. Q20: Issues with Multi not starting when CCGX is connected / Caution when powering the CCGX from the AC-out terminal of a VE.Bus Inverter, Multi or Quattro**

Make sure that the GX device and MultiPlus is running the latest firmware version.

If you power the CCGX from an AC adaptor connected to the AC-out port of any VE.Bus product (Inverter, Multi or Quattro), then a deadlock can occur after the VE.Bus products are powered-down for any reason (after any operational fault or during a black start). The VE.Bus devices will not boot-up until the CCGX has power ...but the CCGX will not boot-up until it has power. See FAQ for more information about this.

This deadlock can be rectified by briefly unplugging the CCGX VE.Bus cable at which point you will observe the VE.Bus products will immediately begin to boot-up.

This deadlock can be avoided in two ways:

1. Power the CCGX from the battery; or
2. Cut pin 7 in the VE.Bus cable connected to the CCGX

Cutting/Removing pin 7 of the VE.Bus cable to the CCGX (brown/white according to standard RJ45 Ethernet cable colour coding) allows the VE.Bus products to start up without waiting for the CCGX to boot up first.

Note that when using a Redflow ZBM2/ZCell battery, pin 7 should be cut even if the CCGX is DC powered, to avoid the same deadlock at times when the Redflow battery cluster is at 0% SoC.



The disadvantage of cutting pin 7 is that switching the VE.Bus device off will be less effective: although it will stop charging and inverting, it will still be in standby mode and therefore drawing more current from the battery than if pin 7 had been left in place. Typically this is only relevant in Marine or Automotive systems where it's normal to regularly switch the VE.Bus device off. For those types of systems we recommend that you do not cut pin 7, but simply power the CCGX from the battery.

#### 18.2.21. Q21: I love Linux, programming, Victron and the CCGX. Can I do more?

Yes you can! We intend to release almost all code as open source, but we are not that far yet. What we can offer today is that many parts of the software are in script or other non-compiled languages, such as Python and QML, and therefore available on your Color Control GX and easy to change. Root password and more information is available [here](#).

#### 18.2.22. Q22: How do I change the logo

Type the following address into the web browser of a device connected to the same network. Using this address as a template: [http://\[ip-here\]/logo.php](http://[ip-here]/logo.php) (inserting your device's IP address between the square brackets). The IP address can be found by going to Settings → Ethernet or Wifi. Once the page is loaded, choose an image file from your device. Re-boot the CCGX.

#### 18.2.23. Q23: Multi restarts all the time (after every 10sec)

Please check the remote switch connection on the Multi control PCB. There should be a wire bridge between the left and middle terminal. The CCGX switches a line which enables the power of the Multi control board. After 10 seconds this line is released and the Multi should take over from there. When the remote switch connection is not wired, the Multi is unable to take over it's own supply. The CCGX will retry, the Multi will boot and after 10 seconds stop, and so on.

#### 18.2.24. Q24: What is Error #42?

If the GX device shows an Error #42 - Hardware fault, the flash storage on the device is corrupt. As a result, settings will not be saved (rebooting resets back to default) and other problems will rise.

This error is not recoverable in the field or by repair departments. Contact your dealer for a replacement.

Firmware versions until v2.30 did not report the error. Since v2.30; its visible on the device itself (in the GUI) and on the VRM Portal.

#### 18.2.25. Q25: My GX device reboots itself. What is causing this behavior?

There are several reasons why a GX device may reboot itself.

One of the most common causes is loss of communication with the VRM online portal.

However, this is only true if the "Reboot device when no contact" option (disabled by default) has been enabled in the VRM online portal settings. If there is no contact with the VRM portal for the time period set in 'No contact reset delay', the GX device will

automatically reboot. This process is repeated until communication with the VRM portal is restored. See also [chapter Datalogging to VRM \[75\]](#) - Network watchdog: auto-reboot.

1. Check the network connection between your GX device and the router. See [Troubleshooting data logging \[77\]](#).
2. Preferably use an ethernet connection between your GX device and the router.
3. Tethered or hotspot connections, e.g. with a cell phone, are not reliable and are often interrupted or do not automatically restore the connection once it has been lost. Therefore, this is not recommended.

Other common reasons that cause the GX device to automatically restart are:

- System overload (either CPU, memory, or both).

To reliably detect an overload of the system, there is the D-Bus round trip time (RTT) parameter, and this parameter is available on the VRM Portal. See image below how to set this up on VRM.

An RTT value between 1 and 100ms is fine, although 100ms is already quite high.

RTT peaks occurring now and then are not a problem. Permanently over 100ms is a problem and requires further investigation.

In case the cause is a system overload, then there are two solutions:

1. Disconnect devices to reduce the load, with associated disadvantages.
2. Or change the GX device for a more powerful one. In the current product offering - see our [Victron GX product range](#) -, the Cerbo GX & Cerbo-S GX is (far) more powerful than the CCGX as well as the Venus GX.



An occasional reboot is not causing any harm to system longevity or performance. The main effect is (temporary) disturbance of the monitoring.

#### How to create a custom widget in the VRM portal to read out D-Bus round trip time:

1. Connect to the VRM Portal using a browser.
2. Click on the Advanced tab in the menu on the left side.
3. Click on the widget icon in the top right corner.
4. Scroll down to Custom Widget and click on it to create a new custom widget.
5. Give it a proper name, chose "Gateway" from the list in Select device and "D-Bus round trip time" in Select parameter.
6. After clicking on the Save button, the new widget will appear under the Advanced tab.

Tip: Keep the time period to be examined as small as possible to achieve a high resolution of the round trip time.

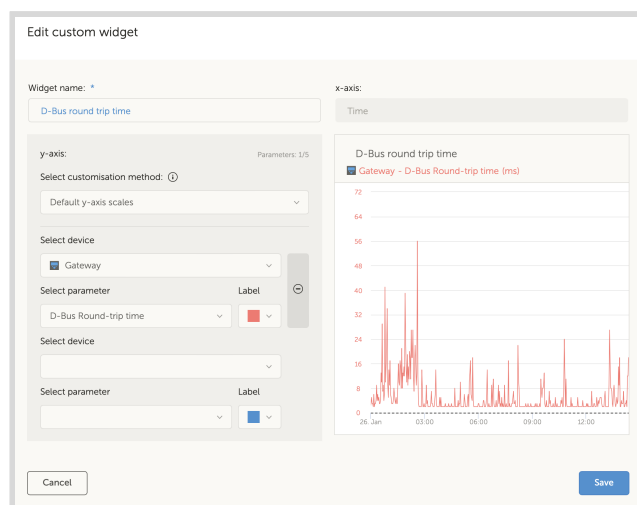

#### 18.2.26. GPL Note

The software included in this product contains copyrighted software that is licensed under the GPL. You may obtain the Corresponding Source code from us for a period of three years after our last shipment of this product.

## 19. Technical specifications

### 19.1. Technical specifications

Color Control GX <sup>(1)</sup>			
Power supply voltage range	8 - 70V DC		
Current draw @	12V DC	24V DC	48V DC
Display off	140mA	80mA	40mA
Display at minimum intensity	160mA	90mA	45mA
Display at maximum intensity	245mA	125mA	65mA
Potential free contact	3A / 30V DC / 250V AC (Normally open)		
Communication ports			
VE.Direct	2 separate VE.Direct ports – isolated		
VE.Can	2 paralleled RJ45 sockets – isolated		
VE.Bus	2 paralleled RJ45 sockets – isolated		
USB	2 USB Host ports – not isolated		
Ethernet	10/100/1000MB RJ45 socket – isolated except shield		
3rd party interfacing			
Modbus-TCP	Use Modbus-TCP to monitor and control all products connected to the Color Control GX		
JSON	Use the VRM JSON API to retrieve data from the VRM Portal		
Other			
Outer dimensions (h x w x d)	130 x 120 x 28mm		
Operating temperature range	-20 to +50°C		
Standards			
Safety	EN 60950-1:2005+A1:2009+A2:2013		
EMC	EN 61000-6-3, EN 55014-1, EN 61000-6-2, EN 61000-6-1, EN 55014-2		
Automotive	E4-10R-053535		

<sup>(1)</sup> For more detailed information about the Color Control GX, please visit the [Victron GX product range page](#).

## 20. Appendix

### 20.1. RV-C

#### 20.1.1. Supported DGNs

This chapter describes which data of the supported devices are available and the corresponding DGNs (Data Group Numbers).

RV-C defines several messages. A detailed specification of the protocol and message definition is publicly available on [RV-C.com](http://RV-C.com).

#### 20.1.2. RV-C out

##### Generic

The GX main RV-C interface and all virtual devices report the minimum required DGNs:

DGN	DGN#	Description
PRODUCT_ID	0xFEED	Manufacturer, product name, serial number
SOFTWARE_ID	0xFEDA	Software version
DM_RV	0x1FECA	Diagnostics
DM01*	0x0FECA	Diagnostics

\* In addition to DGN DM\_RV 0x1FECA, also J1939 DGN DM01 0x0FECA is announced for all RV-C out devices to support older RV-C control panels that do not support the DM\_RV DGN.

##### Main interface

The GX main interface identifies as "Control Panel" (DSA=68) on RV-C and is responsible for requesting and processing data from all RV-C nodes.

##### DC Source messages

All DC connected devices are capable of reporting DC\_SOURCE\_STATUS\_1. This includes the inverter/charger, inverter, charger, battery and solar charger services. VE.Bus Inverter/charger and Battery/BMS reports DC current and voltage, all other devices report voltage only.

According to the RV-C spec, only one node is allowed to broadcast DC source messages from the same instance. Every device type has its own priority which is used to determine which node must send the DC source messages. Consider the following system:

- Inverter/charger (DC source instance 1, prio 100)
- Solar charger (DC source instance 1, prio 90)
- AC charger with 3 outputs (DC source instance 1, 2 & 3, prio 80)
- Battery monitor (DC source instance 1, prio 119)

In this case the battery monitor broadcasts DC source data with instance 1, as this has the highest priority. Additionally the AC charger broadcasts DC source data with instance 2 and 3 (output 2 and 3), as there are no other devices with those instances. More information about DC source messages in the [RV-C specification manual](#). Chapter 6.5.1 explains the priority mechanism.

## VE.Bus Inverter/charger

### Devices

Only VE.Bus MultiPlus/Quattro. Phoenix Inverter VE.Bus is also exported by this service, but then with number of AC inputs set to 0. The DSA is set to 66 (Inverter #1).

### Instances

- Inverter: default instance 1, configurable from 1...13
- Charger: default instance 1, configurable from 1...13
- Line #1: default instance 0 (L1), configurable from 0...1
- Line #2: default instance 1 (L2), configurable from 0...1
- DC source: default instance 1, configurable from 1...250

### Status

DGN	DGN#	Value
INVERTER_AC_STATUS_1	0x1FFD7	L1 AC out voltage, current, frequency L2 AC out voltage, current, frequency <b>L2 data is not sent when not configured</b>
INVERTER_STATUS	0x1FFD4	Inverter status
CHARGER_AC_STATUS_1	0x1FFCA	L1 AC input voltage, current, frequency L2 AC input voltage, current, frequency <b>L2 data is not sent when not configured</b>
CHARGER_AC_STATUS_2	0x1FFC9	Input current limit
CHARGER_STATUS	0x1FFC7	Charger state
CHARGER_STATUS_2	0x1FEA3	DC voltage, current
CHARGER_CONFIGURATION_STATUS	0x1FFC6	Maximum charge current
CHARGER_CONFIGURATION_STATUS_2	0x1FF96	Input current limit, Maximum charge current (%)
DC_SOURCE_STATUS_1	0x1FFFD	DC voltage, current <b>Fixed priority of 100 (inverter/charger)</b>

### Commands

DGN	DGN#	Value
INVERTER_COMMAND <sup>1)</sup>	0x1FFD3	Inverter enable/disable
CHARGER_COMMAND <sup>1)</sup>	0x1FFC5	Charger enable/disable
CHARGER_CONFIGURATION_COMMAND	0x1FFC4	Maximum charge current <b>Note: this is a volatile setting and resets to the value the unit was configured with after a restart of the inverter/charger.</b>
CHARGER_CONFIGURATION_COMMAND_2	0x1FF95	Charger input current limit

<sup>1)</sup> From RV-C you can control the charger and inverter part separately. These two on/off values are then combined into a single switch value (as seen on the VE.Bus page in the GX user interface, see top most item in below screenshot). If the inverter/charger is On, switching the charger off will result in Inverter only. Switching the inverter off will result in Charger only (when shore power is connected).

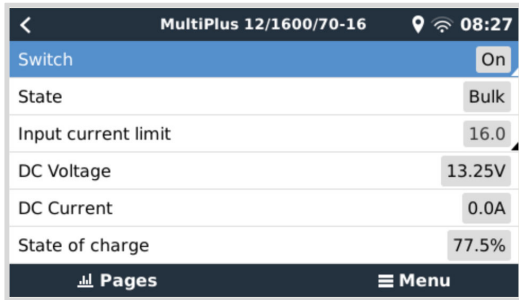

Victron defines the following options to control a combined inverter/charger:

State	Remarks
Off	Both, inverter and charger are switched off
Inverter only	Only the inverter is switched on
Charger only	Only the charger is switched on
On	Both, inverter and charger are switched on

This is reflected by the Switch menu option:



## Inverter

### Devices

Phoenix inverter VE.Direct and Inverter RS. The DSA is set to 66 (Inverter #1).

### Instances

- Inverter: default instance 2, configurable from 1...13
- Line: default instance 0 (L1), configurable from 0...1
- DC source: default instance 1, configurable from 1...250

### Status

DGN	DGN#	Value
INVERTER_AC_STATUS_1	0x1FFD7	L1 AC out voltage, current, frequency
INVERTER_STATUS	0x1FFD4	Inverter status
DC_SOURCE_STATUS_1	0x1FFFD	DC voltage <b>Fixed priority of 60 (inverter)</b>

### Commands

DGN	DGN#	Value
INVERTER_COMMAND	0x1FFD3	Inverter enable/disable/load sense



## AC charger

### Devices

Skylla-I, Skylla-IP44/IP65, Phoenix Smart IP43 Charger. The DSA is set to 74 (Converter #1).

### Instances

- Charger: default instance 2, configurable from 1...13
- Line: default instance 0 (L1), configurable from 0...1
- DC source #1: default instance 1, configurable from 1...250
- DC source #2: default instance 2, configurable from 1...250
- DC source #3: default instance 3, configurable from 1...250

### Status

DGN	DGN#	Value
CHARGER_AC_STATUS_1	0x1FFCA	AC current
CHARGER_AC_STATUS_2	0x1FFC9	Input current limit
CHARGER_STATUS	0x1FFC7	Charger state
CHARGER_STATUS_2	0x1FEA3	DC source #1: voltage, current output 1 DC source #2: voltage, current output 2 DC source #3: voltage, current output 3  <b>Instance 2, 3 are not sent when not present</b>
CHARGER_CONFIGURATION_STATUS_2	0x1FF96	Input current limit
DC_SOURCE_STATUS_1	0x1FFFD	DC source #1: voltage DC source #2: voltage DC source #3: voltage  <b>Instance 2, 3 are not sent when not present. Fixed priority of 80 (charger)</b>

### Commands

DGN	DGN#	Value
CHARGER_COMMAND	0x1FFC5	Charger enable/disable
CHARGER_CONFIGURATION_COMMAND_2	0x1FF95	Input current limit

## Solar charger

### Devices

BlueSolar, SmartSolar, MPPT RS. The DSA is set to 141 (Solar Charge Controller).

### Instances

- Charger: default instance 1, configurable from 1...250
- DC source: default instance 1, configurable from 1...250

### Status

DGN	DGN#	Value
SOLAR_CONTROLLER_STATUS	0x1FEB3	Operating state
SOLAR_CONTROLLER_STATUS_5	0x1FE82	Total yield
SOLAR_CONTROLLER_BATTERY_STATUS	0x1FE80	Battery voltage, current
SOLAR_CONTROLLER_ARRAY_STATUS	0x1FDFF	PV voltage, current

DGN	DGN#	Value
DC_SOURCE_STATUS_1	0x1FFFD	DC voltage <b>Fixed priority of 90 (charger + 10)</b>

## Battery/BMS

### Devices

BMV, SmartShunt, Lynx Shunt, Lynx Ion, Lynx Smart BMS, BMS-Can batteries. The DSA is set to 69 (Battery State of Charge Monitor).

### Instances

- Main: default instance 1, configurable 1...250; default priority 119, configurable 0...120
- Starter: default instance 2, configurable 1...250; default priority 20, configurable 0...120

### Status

DGN	DGN#	Value
DC_SOURCE_STATUS_1	0x1FFFD	Voltage, current <b>Starter instance not sent if starter battery is not present</b>
DC_SOURCE_STATUS_2	0x1FFFC	Temperature, soc, time remaining
DC_SOURCE_STATUS_4	0x1FEC9	Desired maximum voltage, current

## Tanks

### Devices

Built-in tanks, GX tank, N2K tanks. The DSA is set to 73 (LPG) for LPG tanks and 72 (Water/Waste Tank System) for all other tank types.

### Instances

- Tank: default instance 0, configurable from 0...15

### Status

DGN	DGN#	Value
TANK_STATUS	0x1FFB7	Fluid type, relative level, absolute level, tank size Resolution fixed to 100

RV-C supports only 4 tank types (0..3), while Victron supports up to 11 tank types. The table with the additional tank types is Victron specific and is compatible with the tank types we use.

### Supported tank types:

Venus / NMEA 2000		RV-C
Fluid type	Fluid code	Type
Fuel	0	4 (Vendor defined)
Fresh water	1	0
Waste (Grey) water	2	2
Livewell	3	5 (Vendor defined)
Oil	4	6 (Vendor defined)
Black water	5	1
Gasoline	6	7 (Vendor defined)
Diesel	7	8 (Vendor defined)
LPG	8	3
LNG	9	9 (Vendor defined)
Hydraulic oil	10	10 (Vendor defined)
Raw water	11	11 (Vendor defined)

Note that Vendor defined means that these types are not defined in RV-C, but only used for Victron RV-C devices.

### 20.1.3. DGN 60928 Unique Identity Numbers

The GX device will assign an individual Unique Identity Number to each virtual device. Change it only when using multiple GX devices in one RV-C network.

The Unique Identity Number is used for the GX internal CAN-bus device "database" to compare devices during address determination. To avoid clashes on CAN-Bus you must set the second GX device to the unique identity range of 1000-1499. This can be done by setting the unique identity selector to 2 ( $2 * 500$ ). This works exactly the same as for VE.Can, see the [PGN 60928 NAME Unique Identity Numbers \[108\]](#) section.

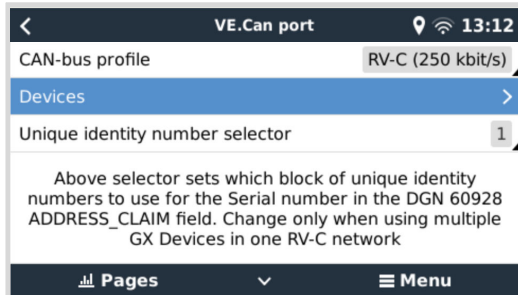

### 20.1.4. RV-C in

#### Tanks

Tested with Garnet SeeLevel II 709 and tanks from the RV-C out function of another GX device.

#### Batteries

Lithionics is the only supported RV-C battery (including DVCC support).

### 20.1.5. Device Classes

This section provides a basic overview of how each device class will participate in the RV-C specification. In any case, "Level 1" integration is largely supported (basic operation), with case-by-case enhancements.

#### AC standalone Chargers

- The AC-based charger class reports its operational status and configuration status using the CHARGER\_xx group of RV-C messages. User control must include basic on/off switching via RV-C as well as adjusting shore (AC) power limits.

#### AC standalone Inverters

- This class of AC inverters reports its operational status using the INVERTER\_xx group of RV-C reports. Incoming command is limited to on/off (enable/disable) via RV-C.

#### AC Charger / Inverter

- Combined inverter/charger - reports both CHARGER\_xx and INVERTER\_xx messages.

#### Solar Controllers

- Solar chargers will report their operational status in real time.

#### SOC Meters

- SOC meters can be used to report current battery health via RV-C: voltage, current, temperature, SOC, etc. RV-C requires that only ONE device speaks for a given battery at a time, so if a proper BMS is installed, that will be the data source.

#### BMS (Victron, or Victron 3rd party supported)

- In many cases, the battery(s) in the system will be directly attached to a Victron Cerbo GX or Cerbo-S GX, either via Victron equipment or via supported 3rd party compatible BMSs. Such batteries should be represented into the RV-C environment via the DC\_SOURCE\_STATUSxx messages.

#### Tank Level meters

- Tank meters will be translated into RV-C messages, carrying forward the existing tank ID/ VRM Instance numbers.

### 20.1.6. Instance Translation

RV-C utilises Instances in several ways:

- DC Source Instance
- AC Line
- Device Instance (context dependent)

Each usage of the Instance has a specific meaning, and a given device may at times utilise one or more of these instances.

#### DC Source Instance

In RV-C, a DC source is something that can generate and (optionally) store energy. Typically a battery but can also be a fuel cell or the output side of a DC contactor/disconnector.

A DC source can be thought of as a battery system and its associated physical bus, for example, the house battery, the DC bus bar and DC wiring. DC Source Instances are used to associate subsequent devices (e.g. a charger or an inverter) to the 'DC bus' it is connected to.

In this way it is possible to map out how all devices are connected with regards to their DC bus via their DC Source Instance value (starter battery and its alternator, house battery and its chargers etc.).

Note that in some cases (e. g. a DC-DC Converter or a Contactor), a device may be associated with two different DC Source instances. For example, a DC-DC converter could be associated with the two different batteries to which it is connected, while a contactor could be associated with the battery to which it is connected; the DC bus on the load side of the contactor then has its own DC Source instance

Though Victron is able to support more than one battery (a house and starter battery), the primary focus is on one battery. The dbus-rvc module will present the 'primary' battery to RV-C as 'DC Source Instance = 1' (house battery) information.

If present, additional Victron sensing devices will be presented using DC Source Instances of 2. An example is the optional starter battery voltage sensing on SmartShunts.

#### AC Line

AC line is much simpler, in that RV-C assumes a limited AC system, typically defined as Line 1 or Line 2. Victron supports 3-phase systems, which is not included in the RV-C specification. All installations with 3-phase systems are not supported by the dbus-RVC module and AC-related RV-C messages are suppressed.

#### Device Instance

Device Instance is a way to separate different physical devices of the same type. Example: if an installation contains two AC chargers attached to the same battery, each would be assigned a separate Device Instance while both would share the same DC Source Instance. Each charger would also be associated with an AC line, which may or may not be the same. In this way the AC charger is fully described in how it is wired on the AC and DC side while being able to be uniquely identified through its Device Instance.

Devices Instances are relevant within a given class of devices. An AC charger can define Device Instances 1 and 2, and these are unrelated to Device Instances 1 and 2 of a DC motor controller.



With the exception of tank monitoring, Device Instances are hard coded as 1 for each specific device class unless specified otherwise in the PGN table. Because the AC charger has a hardcoded instance of 2, to allow coexistence with a inverter/charger with charger instance 1.

### 20.1.7. RV-C Fault and Error Handling

#### RV-C fault reporting:

- Fault conditions are reported using the DM\_RV (0x1FECA) and J1939 DM01 (0x1FECA) DGNs.
- In release 1 the operational status bits, the yellow and the red light field are supported because they are stored in DSA.
- SPN is set to 0xFFFFFFFF during normal conditions, and 0x0 at any time a warning or fault condition exists in supported Victron equipment.
- FMI is set of 0x1F (Failure mode not available) at all times.

This simple mapping allows external user displays to indicate an alarm or fault condition in a given Victron device, at which time the user should utilise Victron diagnostic aids for additional insight.

### 20.1.8. RV-C Device Priority

A critical concept in RV-C is the application of *Device Priorities*.

When used, a given device's priority will impact if it is allowed to transmit DGNs (e.g. a BMS with a higher priority should transmit details of the battery's status, while a MPPT controller with a lower priority should back down).

*Device Priority* is also at times used to allow for the favouring of one node vs. another, for example, it may be more desirable to use shore power AC vs. the inverter.

In the implementation of dbus-rvc, the following priorities will be hard coded into transmitted messages:

- DC\_SOURCE\_STATUS\_xx messages: Priority = 119 (SOC/BMS) to allow native RV-C batteries have a higher priority.
- SOLAR\_xx messages: Charger Priority = 110
- CHARGER\_xx messages (Inverter/Chargers):: Charger Priority = 100
- CHARGER\_xx messages (AC Chargers):: Charger Priority = 80

## 20.2. Color Control GX Dimensions

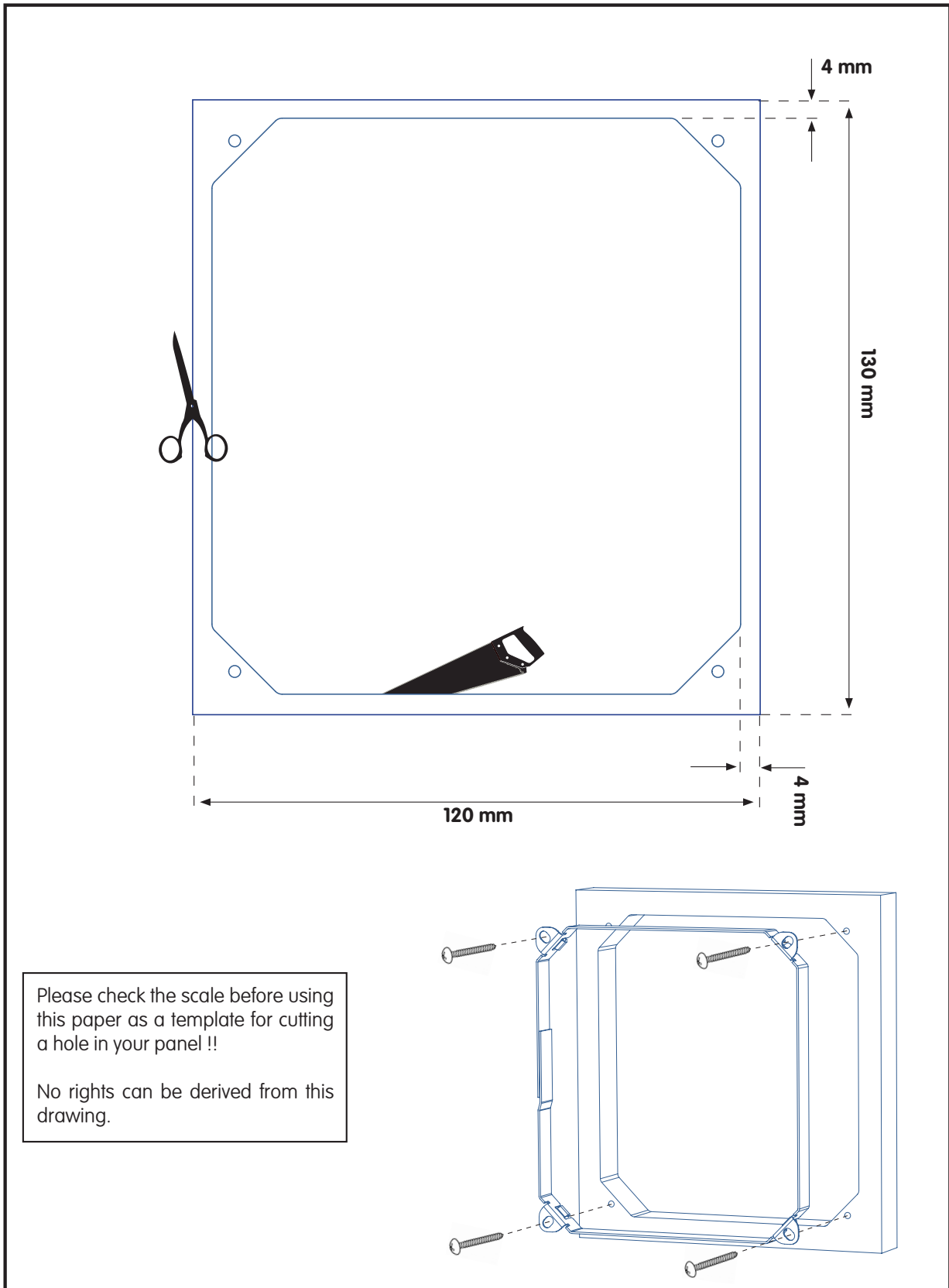

## 20.3. Modbus holding registers for the ComAp IntelliLite 4 controller

The following table lists the required ComAp Modbus configuration.

The registers must be adjusted using the IntelliConfig software using the register list below. The register positions between the specified registers may have to be filled with other values, as querying register groups containing undefined registers can lead to a communication error. Depending on genset, the values of RPM, Coolant Temp, Oil Pressure and Fuel Level may be reported by the ECU instead (Com.Obj. 10153 to 10172). The "Units/Power format" setting must remain at the default settings "Metric - 20 °C, 10.0 Bar, 11.4 l/h" for Units and "Standard 1kW/kVA/kVAr 1V" for Power Format.

In addition to the listed holding registers, Coil 4700 is used to start and stop the genset.

**Table 1. Holding registers**

Register(s)	Com. Obj.	Name	DIM	Type	Dec	Group
01004	10123	EngineSpeed	rpm	int16	0	Engine
01006	9152	T-Coolant	°C	int16	0	Controller I/O
01008	9151	P-Oil	bar	int16	1	Controller I/O
01013 - 01014	8206	Running Hours	h	int32	1	Statistics
01020	8202	Load P	kW	int16	0	Load
01021	8524	Load P L1	kW	int16	0	Load
01022	8525	Load P L2	kW	int16	0	Load
01023	8526	Load P L3	kW	int16	0	Load
01036	8210	Generator Frequency	Hz	uint16	1	Generator
01037	8192	Generator Voltage L1-N	V	uint16	0	Generator
01038	8193	Generator Voltage L2-N	V	uint16	0	Generator
01039	8194	Generator Voltage L3-N	V	uint16	0	Generator
01043	8198	Load Current L1	A	uint16	0	Load
01044	8199	Load Current L2	A	uint16	0	Load
01045	8200	Load Current L3	A	uint16	0	Load
01053	8213	Battery Volts	V	int16	1	Controller I/O
01055	9153	Fuel Level	%	int16	0	Controller I/O
01263 - 01264	8205	Genset kWh	kWh	int32	0	Statistics
01298	9244	Engine State		String list		Info
01301	12944	Connection Type		String list		Info
01307 - 01322	24501	ID String		Long string		Info
01323 - 01330	24339	FW Version		Short string		Info
01382	9887	Controller Mode		string list		Info
03000 - 03007	8637	Gen-Set Name		Short string		Basic Settings / Name



## 20.4. Modbus holding registers for supported DSE genset controllers

The following table lists the Modbus holding registers the GX device reads. Note that this Modbus table reflects the DSE register list, not the GX device's. These definitions follow the Deep Sea Electronics GenComm standard (Version 2.236 MF). The Modbus register list for reading this data from the GX device can be found in the [download section](#) on the Victron website.

The registers marked *required* in the Remarks column are critical for identifying the DSE genset controllers in the GX device and for proper operation of the Victron ecosystem with the generator. Don't change them. All other registers are optional.

Note: *Page* and Register *offset* are terminology from the DSE GenComm standard.

**Table 2. Holding registers**

Register(s)	Page	Offset	Name	Units	Remarks
768	3	0	Manufacturer code		Required for DSE controller identification
769	3	1	Model number		
770	3	2	Serial number		
772	3	4	Control mode		
1024	4	0	Oil pressure	kPa	Required for the Victron ecosystem to work properly
1025	4	1	Coolant temperature	°C	
1026	4	2	Oil temperature	°C	
1027	4	3	Fuel level	%	
1029	4	5	Engine battery voltage	V	
1030	4	6	Engine speed	RPM	
1031	4	7	Generator frequency	Hz	
1032	4	8	Generator L1-N voltage	V	
1034	4	10	Generator L2-N voltage	V	
1036	4	12	Generator L3-N voltage	V	
1044	4	20	Generator L1 current	A	
1046	4	22	Generator L2 current	A	
1048	4	24	Generator L3 current	A	
1052	4	28	Generator L1 watts	W	
1054	4	30	Generator L2 watts	W	
1056	4	32	Generator L3 watts	W	
1536	6	0	Generator total watts	W	
1558	6	22	Generator % of full power	%	
1798	7	6	Engine run time	Seconds	
1800	7	8	Generator pos. kWh hours	kWh	
1808	7	16	Number of starts		
From 2048	8		Alarm conditions		
4096 to 4103	16		Control registers		
From 39424	154		Alarm conditions		